

**Flange Connection**

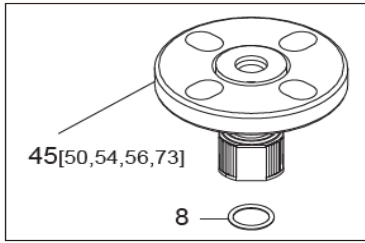

**GF Connection**

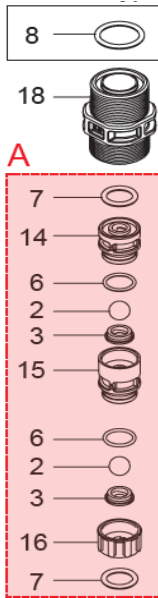

**NPT Connection**

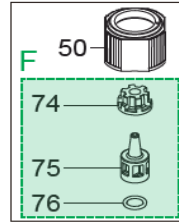
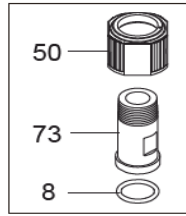

**Tubing Connection**

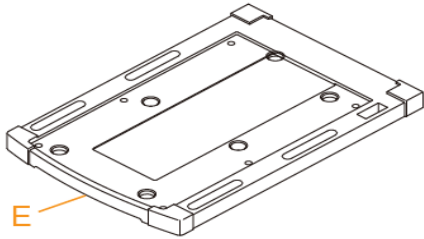

NO.	DESCRIPTION	QTY
A	Valve set	2
D	Diaphragm set	1
E	Base	1
F	Connector set	2
1	Pump head	1
2	Valve	4
3	Valve seat	4
6	O-ring	4
7	O-ring	4
8	O-ring	2
14	Valve guide A	2
15	Valve guide B	2
16	Seat holder	2
17	IN Adapter	1
18	OUT Adapter	1
19	Hex socket head bolt	4
20	Spring washer	4
21	Plain washer	4
28	Bolt cover	1
30	Diaphragm unit	1
31	Retainer	1
32	Diaphragm sheet	1
33	Diaphragm stopper	1
34	Gasket	1
35	Bracket spacer	1
45	Flange unit	2
50	Nut	2
54	Flange	2
56	Flange adapter	2
73	Fitting	2
74	Hose stopper	2
75	Hose adapter	2
76	O-ring	2

\*1 T models  
 \*2 N/FA models  
 \*3 FA models  
 \*4 N/T/FA models  
 \*5 N/FA models

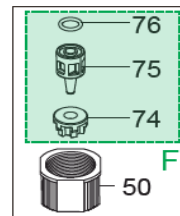
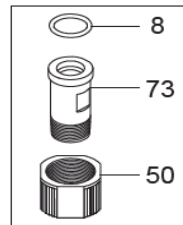
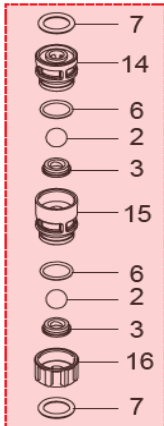
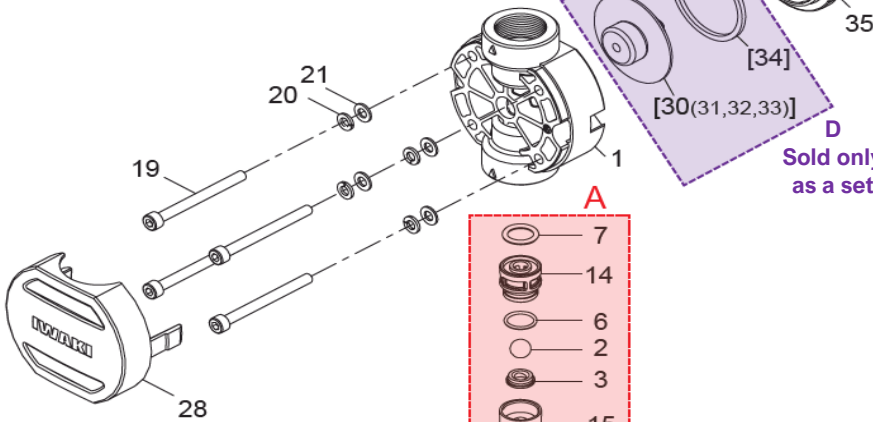

**Tubing Connection**

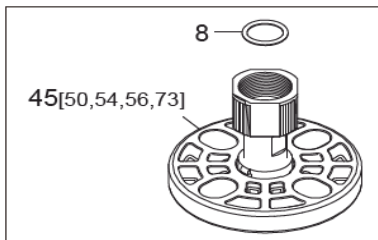

**Flange Connection**

**GF Connection**

**NPT Connection**

**NOTES:**

1. Actual parts may differ from the illustration.
2. Individual parts shown in "[ ]" are not available - they are part of an assembly.
3. The GF (George Fischer) connection is part of the NPT connection model code.

**IX-B015TC/TE Pumps**

NO.	DESCRIPTION	MODEL CODE	MATERIAL	SIZE	QTY	CODE	ITEM NOS.	IN SPARE PARTS KIT
1	Pump head		PVDF		1	IX0294		
2	Valve		AL CE	3/8"	4	IX0249		*
3	Valve seat	TC	FKM		4	IX0250		*
		TE	EPDM		4	IX0251		*
6	O-ring	TC	FKM	S-14	4	IX0252		*
		TE	EPDM	S-14	4	IX0253		*
7	O-ring	TC	FKM	P-12	4	IX0254		*
		TE	EPDM	P-12	4	IX0255		*
8	O-ring	TCN / TCFA	FKM	P-18	2	IX0256		*
		TEN / TEFA	EPDM	P-18	2	IX0257		*
14	Valve guide A		PVDF		2	IX0258		*
15	Valve guide B		PVDF		2	IX0259		*
16	Seat holder		PVDF		2	IX0260		*
A	Valve set	TC			2	IX0283	(2,3,6,7,14,15,16)	
		TE			2	IX0284	(2,3,6,7,14,15,16)	
17	IN Adapter		PVDF		1	IX0261		
18	OUT Adapter		PVDF		1	IX0262		
19	Hex soc head bolt		SS	M5x55	4	IX0263		
20	Spring washer		SS	M5	4	IX0264		
21	Plain washer		SS	M5	4	IX0265		
28	Bolt cover		PPE		1	IX0266		
D	Diaphragm set		PTFE/PVDF		1	IX0298	(30,34)	*
35	Bracket spacer		GFRPP		1	IX0297		
45	Flange unit	TCFA / TEFA			2	IX0270	(50,54,56,73)	
50	Nut	TCN / TEN	GFRPP		2	IX0271		
		TCT / TET	GFRPP		2	IX0272		
73	Fitting	TCN / TEN	PVDF	1/2-14NPT	2	IX0274		
74	Hose stopper	TCT / TET	PPS	3/8 x 1/2 T	2	IX0278		*
75	Hose adapter	TCT / TET	PVDF	1/4 x 3/8 T	2	IX0280		*
76	O-ring	TCT	FKM	P-9	2	IX0281		*
		TET	EPDM	P-9	2	IX0282		*
E	Base		GFRPP		1	IX0333		
F	Connector set	TCT		1/4"x3/8"	2	IX0292	(74,75,76)	
		TET		1/4"x3/8"	2	IX0293	(74,75,76)	