

WALCHEM

IWAKI America Inc.

WDT410 Controllers

# WDT410 Series Cooling Tower Conductivity plus pH/ORP Controller Instruction Manual

Five Boynton Road Hopping Brook Park Holliston, MA 01746 USA

TEL: 508-429-1110 FAX: 508-429-7433 WEB: [www.walchem.com](http://www.walchem.com)

## Notice

© 2014 WALCHEM, Iwaki America Inc. (hereinafter "Walchem")  
5 Boynton Road, Holliston, MA 01746 USA  
(508) 429-1110  
All Rights Reserved  
Printed in USA

## Proprietary Material

*The information and descriptions contained herein are the property of WALCHEM. Such information and descriptions may not be copied or reproduced by any means, or disseminated or distributed without the express prior written permission of WALCHEM, 5 Boynton Road, Holliston, MA 01746.*

*This document is for information purposes only and is subject to change without notice.*

## Statement of Limited Warranty

*WALCHEM warrants equipment of its manufacture, and bearing its identification to be free from defects in workmanship and material for a period of 24 months for electronics and 12 months for mechanical parts and electrodes from date of delivery from the factory or authorized distributor under normal use and service and otherwise when such equipment is used in accordance with instructions furnished by WALCHEM and for the purposes disclosed in writing at the time of purchase, if any. WALCHEM's liability under this warranty shall be limited to replacement or repair, F.O.B. Holliston, MA U.S.A. of any defective equipment or part which, having been returned to WALCHEM, transportation charges prepaid, has been inspected and determined by WALCHEM to be defective. Replaceable elastomeric parts and glass components are expendable and are not covered by any warranty.*

*THIS WARRANTY IS IN LIEU OF ANY OTHER WARRANTY, EITHER EXPRESS OR IMPLIED, AS TO DESCRIPTION, QUALITY, MERCHANTABILITY, FITNESS FOR ANY PARTICULAR PURPOSE OR USE, OR ANY OTHER MATTER.*

**180340 Rev. L**  
**April 2014**

## TABLE OF CONTENTS

1.0	INTRODUCTION.....	1
2.0	SPECIFICATIONS .....	2
2.1	Measurement Performance.....	2
2.2	Electrical: Input/Output .....	2
2.3	Mechanical .....	3
2.4	WDT Variables and their Limits.....	3
3.0	UNPACKING & INSTALLATION.....	5
3.1	Unpacking the unit.....	5
3.2	Mounting the electronic enclosure.....	5
3.3	Installation .....	5
3.4	Icon Definitions.....	6
3.5	Electrical installation.....	6
4.0	FUNCTION OVERVIEW .....	13
4.1	Front Panel.....	13
4.2	Display .....	13
4.3	Keypad .....	14
4.4	Access Code .....	14
4.5	Startup .....	14
4.6	Shut Down.....	15
5.0	OPERATION.....	15
5.1	Main Menu.....	15
5.2	Conductivity Menu.....	17
5.3	Temperature Menu.....	19
5.4	pH/ORP Input Menu.....	20
5.5	Bleed Menu .....	24
5.6	Feed Menu .....	26
5.7	WM1 and WM2 Menus.....	29
5.8	pH/ORP Control Menu .....	30
5.9	Bio1 and Bio2 Menus .....	32
5.10	Time Menu.....	36
5.11	Cond Alarm Menu .....	37
5.12	pH/ORP Alarm Menu.....	38
5.13	4-20mA Menu (Optional).....	39
5.14	pH/ORP 4-20mA Menu (Optional).....	40
5.15	Access Code Menu .....	41
5.16	Datalog Menu .....	42
5.17	Config Menu .....	44
5.18	Upgrade Menu.....	45
6.0	MAINTENANCE .....	46
6.1	Electrode Cleaning.....	46
6.2	Replacing the Fuses.....	47
7.0	TROUBLESHOOTING .....	47
7.1	Error Messages .....	47
7.2	Conductivity Readout Does Not Change .....	51
7.3	Procedure for Evaluation of Conductivity Electrode.....	51
7.4	Procedure for evaluation of the pH/ORP electrode.....	51
7.5	Procedure for checking relay outputs.....	52
8.0	SERVICE POLICY .....	53

## 1.0 INTRODUCTION

---

The Walchem WDT410 Series controllers offer conductivity and watermeter-based control of cooling tower water, control of corrosion/scale inhibitor feed, control of two biocide or dispersant pumps and pH or ORP control for acid feed or chlorination/bromination. The inhibitor pump may be selected to operate in one of the following modes:

- Feed and Bleed
- Feed and Bleed with Lockout
- Feed as a percent of Bleed
- Feed as a percent of Time
- Feed based on a Water Contactor input
- Feed based on a Paddlewheel water meter input

The WDT series cooling tower controllers are supplied with a temperature compensated carbon conductivity electrode with a cell constant of 1.0 and a preamplified, pH or ORP electrode depending upon the model ordered. The controllers are microprocessor driven industrial type with on/off control outputs. A timed sample mode may be selected, and on small towers can reduce installation costs by eliminating the need for a sampling bypass line. One or two optional isolated 4-20 mA outputs that are proportional to either conductivity or pH/ORP are available for all models.

Any set point may be viewed without interrupting control. Each set point change will take effect as soon as it is entered. An access code is available to protect set point parameters, while still allowing settings to be viewed.

The biocide outputs are scheduled on a user selectable 1, 2, or 4 week cycle. Each biocide output is independent and may be programmed for one add per day. It is possible to add both chemicals in the same day, however, as a safeguard they will not occur at the same time. Biocide outputs may use independent pre-bleeds and lockout times. All outputs are interlocked with a flow switch input. A daily cycle may also be selected, where the biocide is added up to 10 times per day, every day.

An alarm relay is provided with WDT410 models. It is triggered by:

- High or Low Conductivity reading
- High or Low pH/ORP reading
- No Flow situation
- Bleed Timeout
- pH or ORP Pump Timeout
- Conductivity Sensor Error
- Temperature Sensor Error
- pH or ORP Sensor Error

Our unique USB feature provides the ability to upgrade the software in the controller to the latest version.

An advanced USB capability option is available. The Config file feature allows you to save all the set points from a controller onto a USB flash disk, and then import them into another controller, making the programming of multiple controllers fast and easy. The data logging feature allows you to save the last months readings and events to a USB flash disk.

## 2.0 SPECIFICATIONS

---

### 2.1 Measurement Performance

Conductivity Range	0 - 10,000 $\mu\text{S}/\text{cm}$ (microSiemens/centimeter)
Conductivity Resolution	1 $\mu\text{S}/\text{cm}$
Conductivity Accuracy	10 - 10,000 $\mu\text{S}/\text{cm} \pm 1\%$ of reading 0 - 10 $\mu\text{S}/\text{cm} \pm 20\%$ of reading
Temperature Range	32 – 158°F (0 – 70°C)
Temperature Resolution	0.1°C
Temperature Accuracy	$\pm 1\%$ of reading
pH Range	-2 to 16 pH units
pH Resolution	0.01 pH units
pH Accuracy (Calibrated)	$\pm 0.01$ pH units
ORP Range	$\pm 1500$ mV
ORP Resolution	1 mV
ORP Accuracy(Calibrated)	$\pm 1$ mV

### 2.2 Electrical: Input/Output

<b>Input Power</b>	100-240 VAC, 50/60 Hz, 8A Fuse: 1.0 ampere, 5 x 20 mm
<b>Input Signals</b>	
Cond Electrode:	1.0 cell factor, 10K thermistor
pH/ORP	Requires a preamplified signal. Walchem WEL series recommended. $\pm 5\text{V}$ power available for external preamps. Note: Temperature compensation for pH input is accomplished using the conductivity electrode temp element. ORP measurement does not use temp comp.
Flow Meter (optional)	Isolated, dry contact closure required (i.e. relay,reed switch)
Flow Switch (optional)	Isolated, dry contact closure required (i.e. reed switch)
<b>Outputs</b>	
Mechanical Relays	Pre-powered on circuit board switching line voltage 6 A (resistive), 1/8 HP All relays are fused together as one group, total current for this group must not exceed 6A
4 - 20 mA (0,1, or 2 optional)	Internally powered Fully isolated 600 Ohm max resistive load Resolution .001% of span Accuracy $\pm 1\%$ of reading
<b>Agency Approvals</b>	
Safety	UL 61010-1:2012 3rd Ed. CSA C22.2 No. 61010-1:2012 3rd Ed. IEC 61010-1:2010 3rd Ed. EN 61010-1:2010 3rd Ed.
EMC	IEC 61326-1:2005 EN 61326-1:2006

Note: For EN61000-4-6, EN61000-4-3 the controller met performance criteria B.

\*Class A equipment: Equipment suitable for use in establishments other than domestic, and those directly connected to a low voltage (100-240 VAC) power supply network which supplies buildings used for domestic purposes.

## 2.3 Mechanical

Enclosure Material	Polycarbonate
NEMA Rating	NEMA 4X
Dimensions	8.5" x 6.5" x 5.5"
Display	2 x 16 character backlit liquid crystal
Operating Ambient Temp	32 – 122°F (0 – 50°C)
Storage Temperature	-20 – 180°F (-29 – 80°C)
Graphite electrode pressure rating	150 psi
pH/ORP electrode pressure rating	100 psi
Stainless steel electrode pressure rating	150 psi
High pressure electrode & flow switch manifold pressure rating	300 psi
Flow switch manifold pressure rating	150 psi
Flow switch manifold connections	¾" NPTF

## 2.4 WDT Variables and their Limits

		Low Limit	High Limit
<b>Conductivity menu</b>			
	PPM Conversion Factor	0.200 ppm/μS/cm	1.000 ppm/μS/cm
	Interval Time (sampling)	5 minutes	24:00 hours
	Duration Time (sampling)	1 minute	59 min: 59 sec
	% Calibration Range	-50	+50
<b>Temperature Menu</b>			
		No variables	
<b>pH Input Menu</b>			
	Days Between Cal	1-99 days	0=no reminder
<b>Bleed Menu</b>			
	Set Point	0 μS/cm	10,000 μS/cm
	Dead Band	5 μS/cm	500 μS/cm
	Bleed Limit Time (set in hours/minutes)	1 minute	8 hrs: 20 min (enabled) 0=unlimited (disabled)
	Bleed Volume	1 (gallons or liters)	9,999 (gallons or liters)
	Makeup Volume	1 (gallons or liters)	9,999 (gallons or liters)
<b>Feed Menu</b>			
	Feed Lockout Timer (Mode A)	1 second	99 min: 59 sec
	Percent of Bleed (Mode B)	1 %	99 %
	Feed Time Limit (Mode B)	1 minute	99 min: 59 sec
	Percent of Time (Mode C)	0.1 %	99 %
	Feed Cycle Time (Mode C)	10 minutes	59 min: 59 sec
	Time per Contact (Mode D)	1 second	59 min: 59 sec
	÷ Contacts by (Mode D)	1 contact	100 contacts
	Time Limit (Mode D & E)	1 minute	99 min: 59 sec
	Time/Vol (Mode E)	1 second	59 min: 59 sec
	Vol to Initiate Feed (Mode E)	1	9,999
<b>WM1 and WM2 Menus</b>			
	Gallons per Contact	1 gal/contact	1000 gal/contact
	Liters per Contact	1 L/contact	1000 L/contact
	K Factor (Paddlewheel)	0.01 pulse/vol	9,999.99 pulses/vol
<b>pH/ORP Control Menu</b>			
	Set Point	0 pH/-1500 mV	14 pH/1500 mV
	Dead Band	0.01 pH/1 mV	1.99 pH/999 mV
	Time Limit	0:01-8:59 hrs	0:00=no limit

## WDT Variables and their Limits (continued)

Biocide Menu		Low Limit	High Limit
	Pre-Bleed	1 $\mu$ S/cm	9,999 $\mu$ S/cm (0 disables pre-bleed)
	Lockout Add Time	0 minutes	10 hours
	Daily Adds	0 minutes	144 minutes
	All other modes	0 minutes	1440 minutes
<b>4-20 mA Menu</b>			
	4 & 20 mA Settings	0 $\mu$ S/cm	10,000 $\mu$ S/cm
<b>pH/ORP mA</b>			
	4 & 20 mA Settings	0 pH/-1500 mV	14 pH/1500 mV
<b>Access Code</b>			
	New Value	0	9999
<b>Alarms*</b>			
	High & Low conductivity (zero disables alarm)	1 %	50 %
	High & Low pH/ORP	0 pH/-1500 mV	14 pH/1500 mV
<b>Datalog Menu (optional)</b>		No variables	
<b>Config Menu (optional)</b>		No variables	
<b>Upgrade Menu</b>		No variables	

\*Note: The Alarm relay is non-programmable. Refer to the Main Menu diagram on page 16 for the list of error conditions that trigger the alarm relay.

## 3.0 UNPACKING & INSTALLATION

---

### 3.1 Unpacking the unit

Inspect the contents of the carton. Please notify the carrier immediately if there are any signs of damage to the controller or its parts. Contact your distributor if any of the parts are missing. The carton should contain: a WDT410 series controller and an instruction manual. Any options or accessories will be incorporated as ordered.

### 3.2 Mounting the electronic enclosure

The WDT410 series controller is supplied with mounting holes on the enclosure. It should be wall mounted with the display at eye level, on a vibration-free surface, utilizing all four mounting holes for maximum stability. Use M6 (1/4" diameter) fasteners that are appropriate for the substrate material of the wall. The enclosure is NEMA 4X rated. The enclosure is NEMA 4X rated. The maximum operating ambient temperature is 122°F (50°C); this should be considered if installation is in a high temperature location. The enclosure requires the following clearances:

Top:	2" (50 mm)
Left:	8" (203 mm) (not applicable for prewired models)
Right:	4" (102 mm)
Bottom:	7" (178 mm)

### 3.3 Installation

Once the WDT410 series controller is mounted, the metering pumps may be located at any distance from the controller. The conductivity electrode should be placed as close to the controller as possible, to a maximum distance of 250 ft. Under 25 ft is recommended. The cable must be shielded from background electrical noise. Always route low voltage (sensor) signals with at least a 6" separation from AC voltage wiring.






The pH/ORP electrode should be placed with the conductivity electrode, to a maximum distance of 1000 feet from the controller. A junction box and shielded cable are available to extend the standard 20 foot length.

Locate the electrodes where an active sample of cooling tower water is available and where the electrodes can easily be removed for cleaning. They must be situated so that the tee is always full and the electrodes are never subjected to a drop in water level resulting in dryness. Refer to Figure 1 for typical installation.

**IMPORTANT:** To avoid cracking the female pipe threads on the supplied plumbing parts, use no more than 3 wraps of Teflon tape and thread in the pipe FINGER tight plus 1/2 turn! *Do not use pipe dope to seal the threads of the flow switch because the clear plastic will crack!*





### 3.4 Icon Definitions

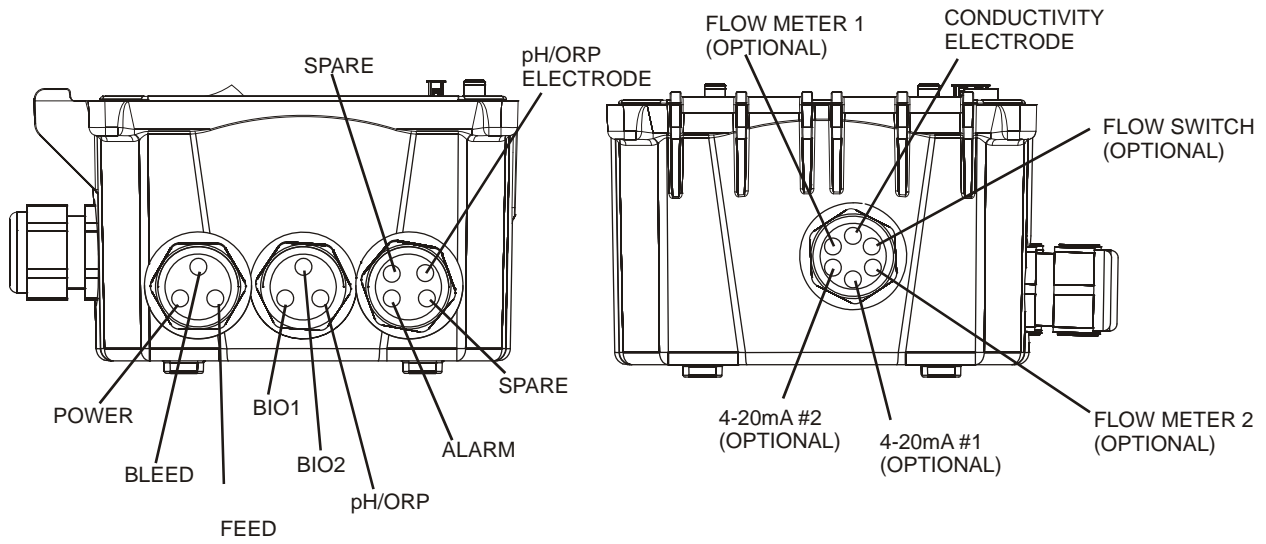
Symbol	Publication	Description
	IEC 417, No.5019	Protective Conductor Terminal
	IEC 417, No. 5007	On (Supply)
	IEC 417, No. 5008	Off (Supply)
	ISO 3864, No. B.3.6	Caution, risk of electric shock
	ISO 3864, No. B.3.1	Caution

### 3.5 Electrical installation

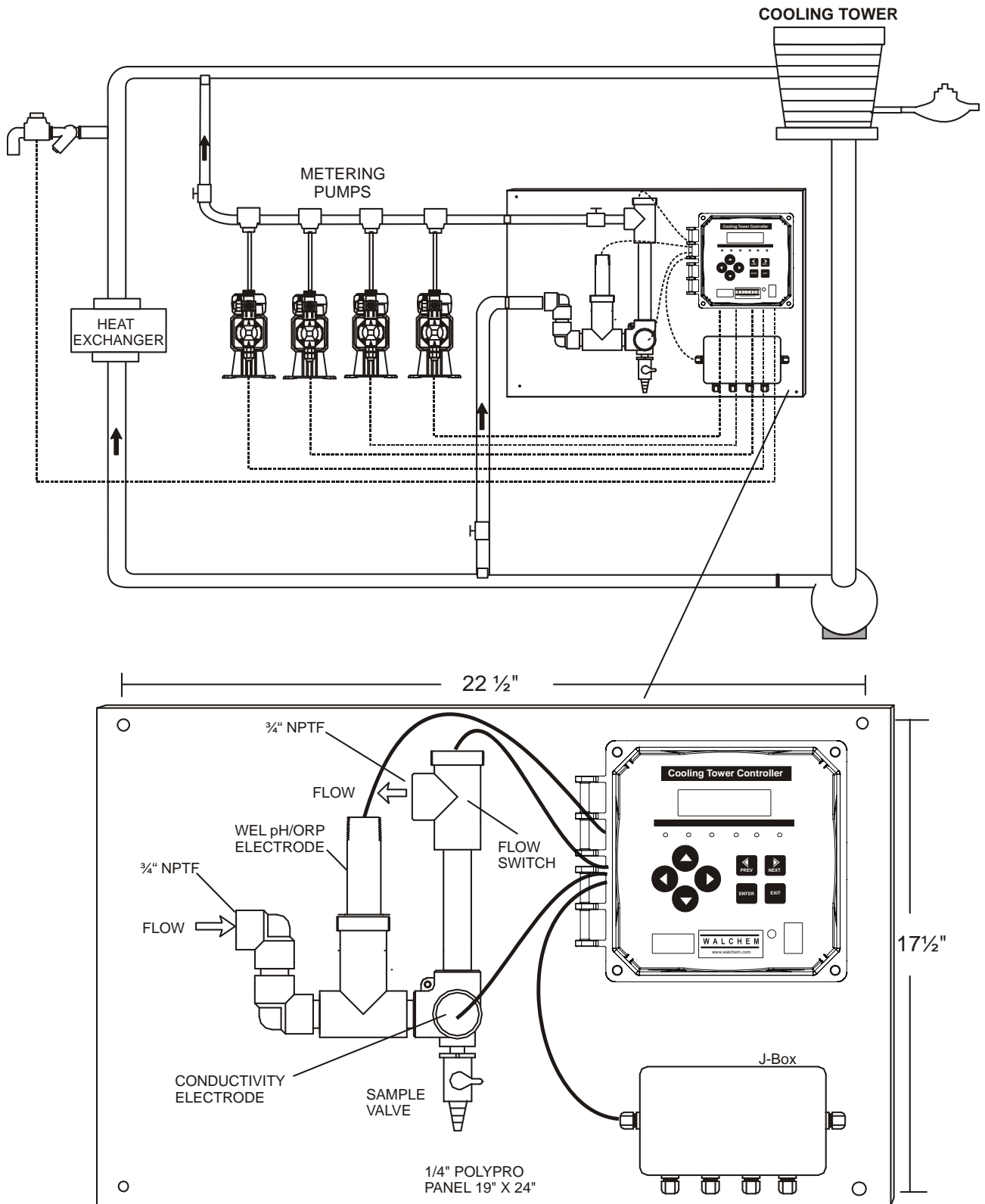
The various standard wiring options are shown in figure 2, below. Your WDT410 series controller will arrive from the factory prewired or ready for hardwiring. Depending on your configuration of controller options, you may be required to hardwire some or all of the input/output devices. Refer to figures 3 and 4 for circuit board layout and wiring.

Note: when wiring the optional flow meter contactor input, the 4-20 mA output or a remote flow switch, it is advisable to use stranded, twisted, shielded pair wire between 22-26 AWG. Shield should be terminated at the controller ground stud (see figures 3 and 4).

	<b>CAUTION</b>	
<ol style="list-style-type: none"> <li>1. There are live circuits inside the controller even when the power switch on the front panel is in the OFF position! The front panel must never be opened before power to the controller is REMOVED! If your controller is prewired, it is supplied with a 8 foot, 18 AWG power cord with USA style plug. A tool (#1 Phillips driver) is required to open the front panel.</li> <li>2. When mounting the controller, make sure there is clear access to the disconnecting device!</li> <li>3. The electrical installation of the controller must be done by trained personnel only and conform to all applicable National, State and Local codes!</li> <li>4. Proper grounding of this product is required. Any attempt to bypass the grounding will compromise the safety of persons and property.</li> <li>5. Operating this product in a manner not specified by Walchem may impair the protection provided by the equipment.</li> </ol>		

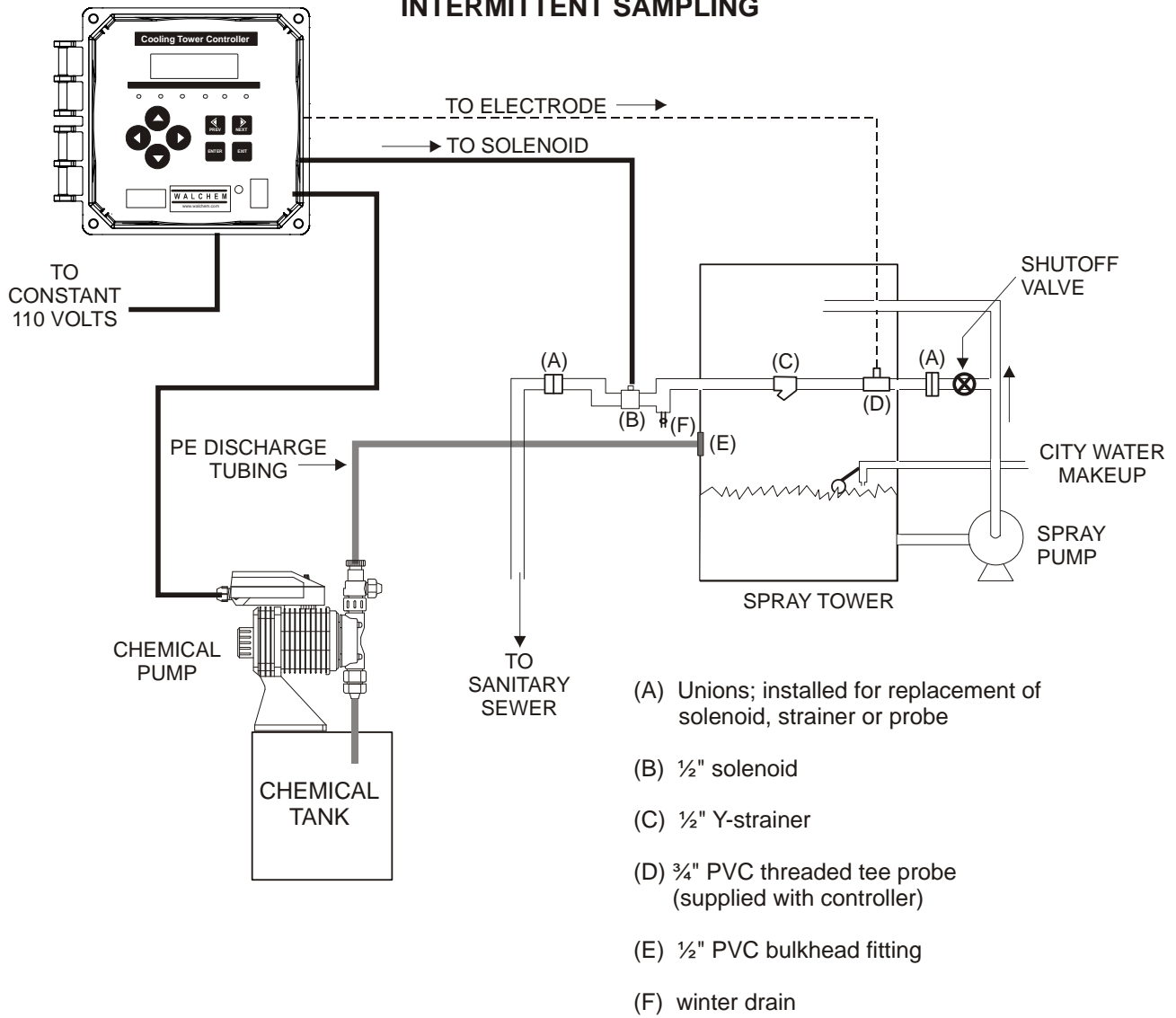


**Figure 1 WDT410 Conduit Wiring**



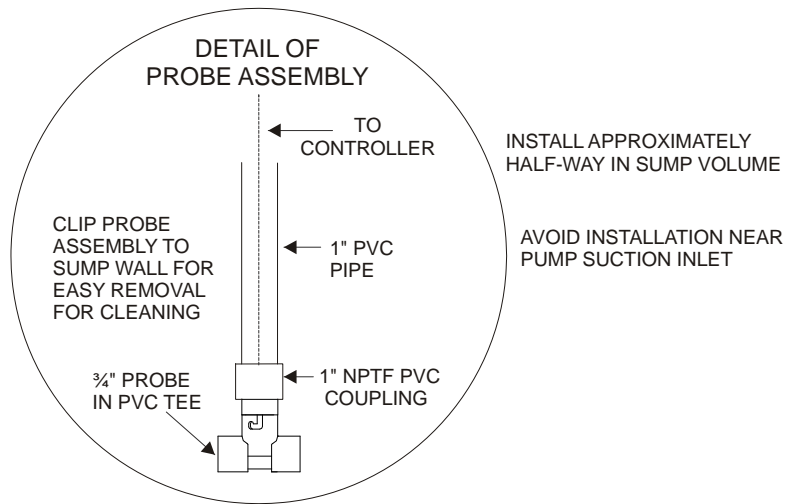
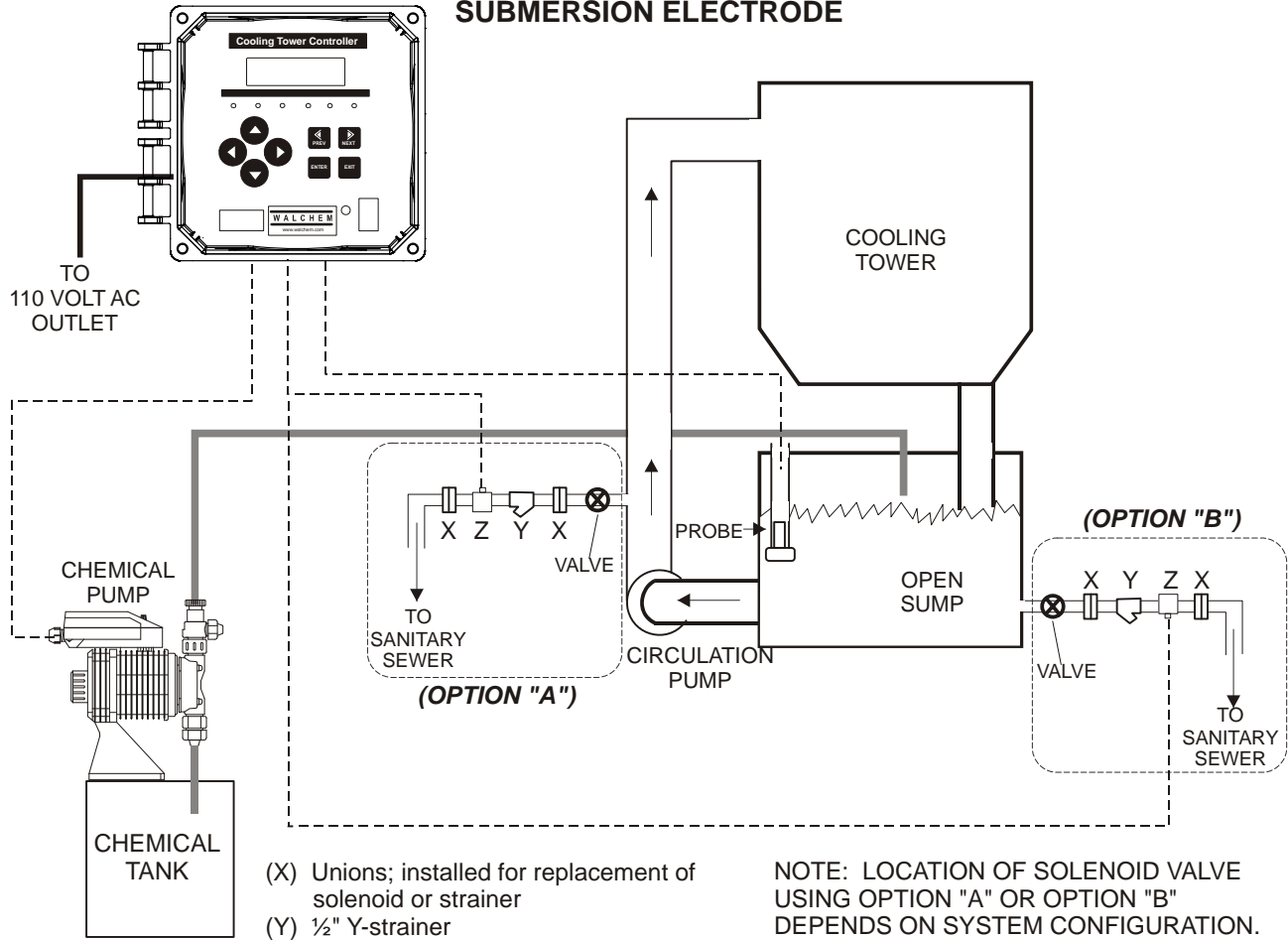
**Figure 2 Typical Installation**

## TYPICAL INSTALLATION INTERMITTENT SAMPLING

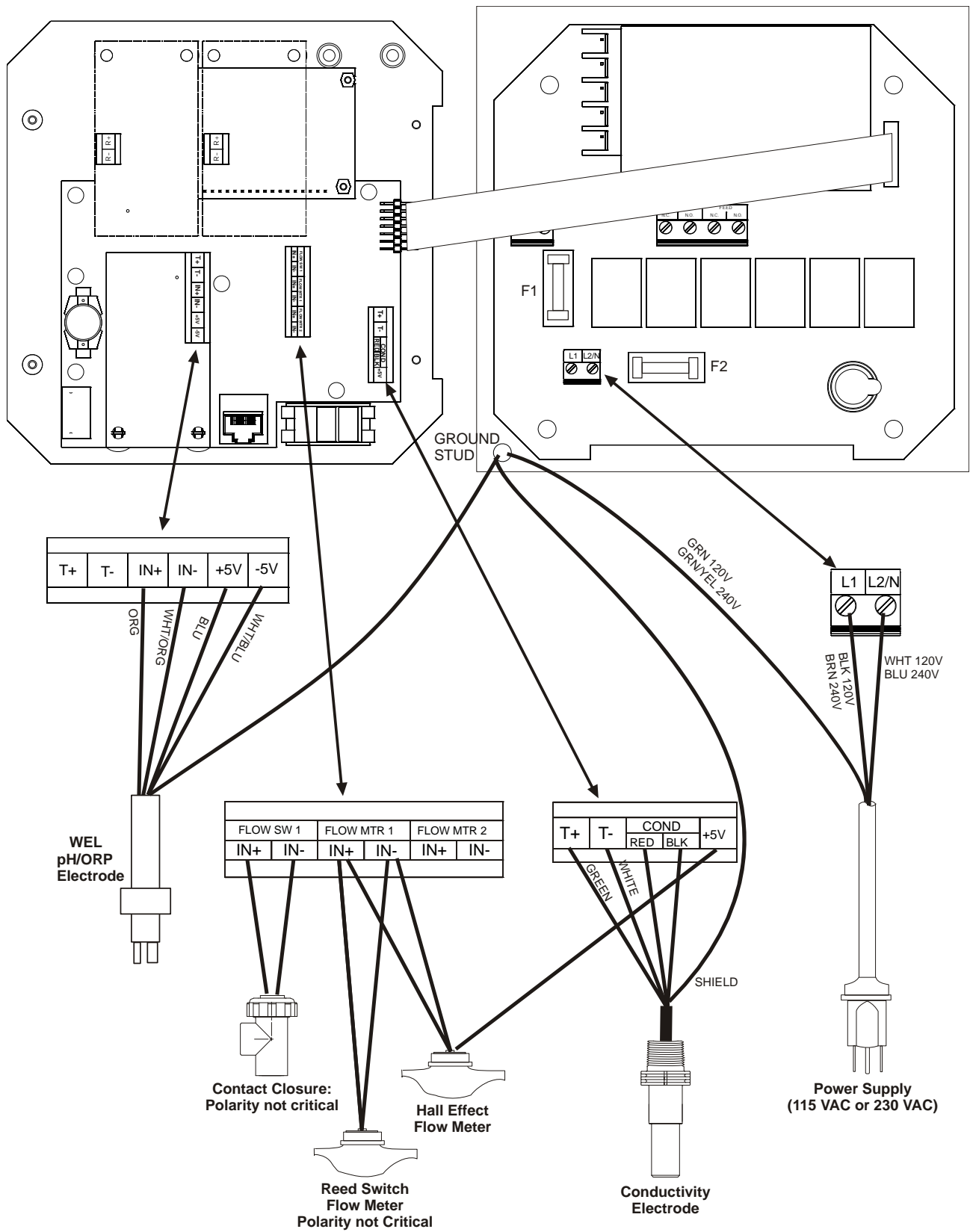


**Figure 2a Typical Installation  
Intermittent Sampling**

## TYPICAL INSTALLATION SUBMERSION ELECTRODE



**Figure 2b Typical Installation  
Submersion Electrode**



**Figure 3 Inputs**

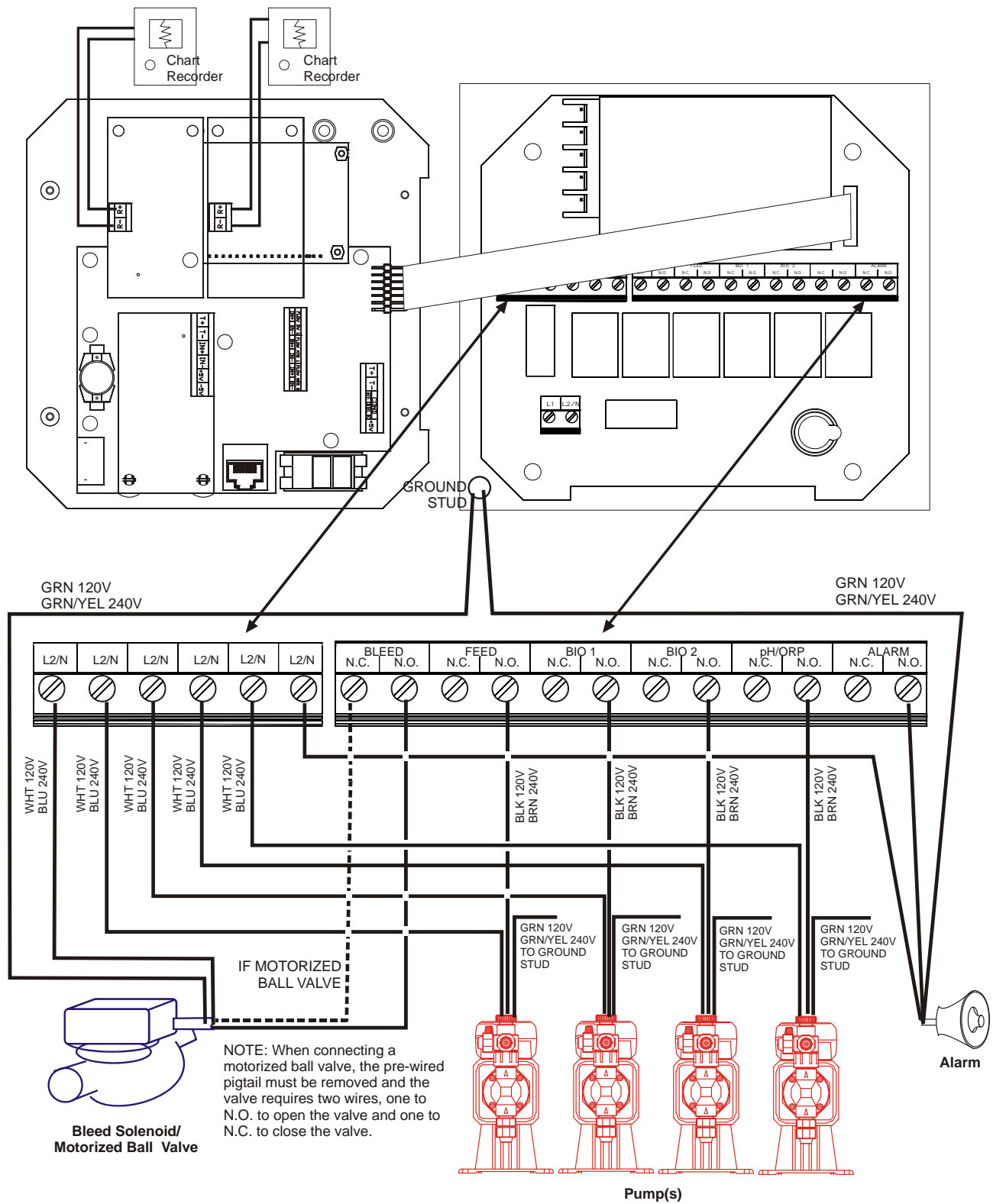


Figure 4 Outputs

## 4.0 FUNCTION OVERVIEW

### 4.1 Front Panel

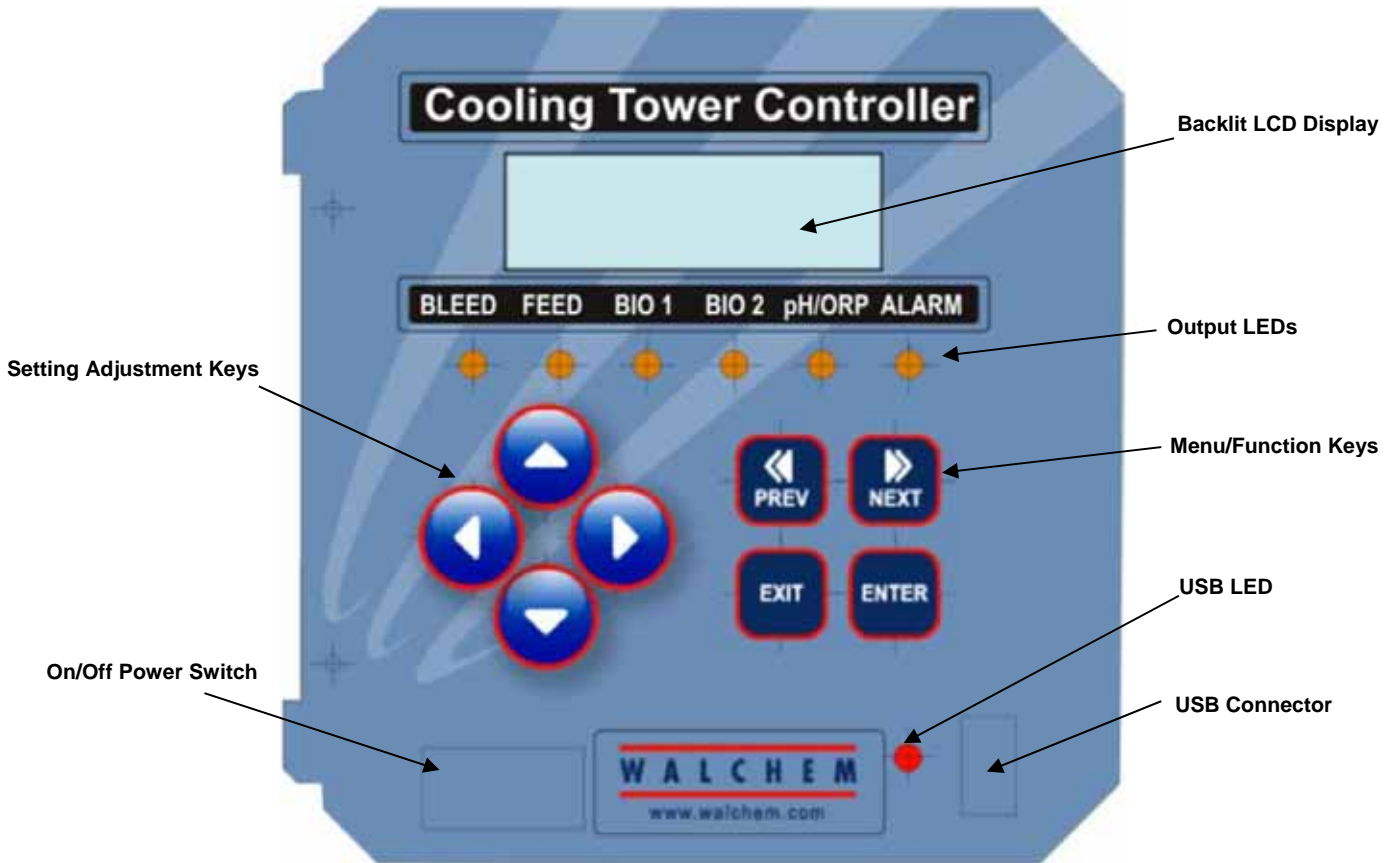


Figure 5 Front Panel

### 4.2 Display

A summary screen is displayed while the WDT410 controller is on. This display shows the conductivity value on the upper left side, the pH/ORP value on the upper right side and current operating conditions. The operating conditions that are displayed on the bottom line of this display are Temp Error, Cond Error, pH or ORP Error, No Flow, Bleed Timeout, pH Timeout, Cond Hi/Lo Alarm, pH/ORP Hi/Lo Alarm, Lockout, Bio 1 Add, Bio 2 Add, Pre Bleed, Feed Timeout, pH or ORP Adjusting, Bleed, Feed, Pending, Waiting, Sample and Normal. Normal just means there is nothing unusual to report.

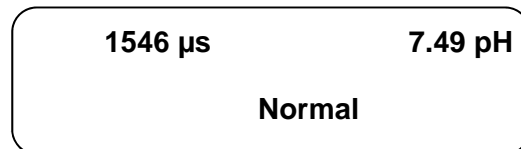


Figure 6 Summary Screen



### 4.3 Keypad

The keypad consists of 4 directional arrow keys and 4 function keys. The arrows are used to move the adjustment cursor and change settings, while the function keys are used to enter values, and navigate the various menu screens. The function keys are ENTER, EXIT, NEXT, and PREV (previous). NEXT and PREV scroll through the various menu choices.



ENTER is used to enter a submenu and to enter a value. EXIT is used to back up one menu level. If you are at the main menu level, EXIT will return you to the Summary Display.

To change a value in a submenu, the left/right arrow keys move the cursor left and right to each digit or option that can be changed. The up/down arrows will change numeric values up or down, or scroll through option choices. Press ENTER only when you have finished making all of the changes for that menu screen.

### 4.4 Access Code

The WDT410 series controller is shipped with the access code disabled. If you wish to enable it, see Section 5.15 for operation. With the access code enabled, any user can view parameter settings, but not change them. Note that this provides protection only against casual tampering. Use a lock on the cover latch if you need more protection.

### 4.5 Startup

#### *Initial Startup*

After having mounted the enclosure and wired the unit, the controller is ready to be started.

Plug in the controller and turn on the power switch to supply power to the unit. The display will briefly show the model number and then revert to the normal summary display. Scroll through the menus and calibrate the conductivity reading, temperature, and set the control parameters detailed in Section 5, Operation.

To return to the summary display, press the EXIT key until you return to this screen. The controller will automatically return to this screen after 10 minutes.

#### *Normal Startup*

Startup is a simple process once your set points are in memory. Simply check your supply of chemicals, turn on the controller, calibrate it if necessary and it will start controlling.

## 4.6 Shut Down

To shut the controller down, simply turn off the power. Programming remains in memory. It is important that the pH/ORP electrode remains wet. If the shutdown is expected for any longer than a day, and it is possible for the electrode to dry out, remove the electrode from the tee and store it in pH 4 buffer or cooling tower water. Take care to avoid freezing temperatures when storing the pH/ORP electrodes to avoid breakage of the glass.

## 5.0 OPERATION

---

These units control continuously while power is applied. Programming is accomplished via the local keypad and display.

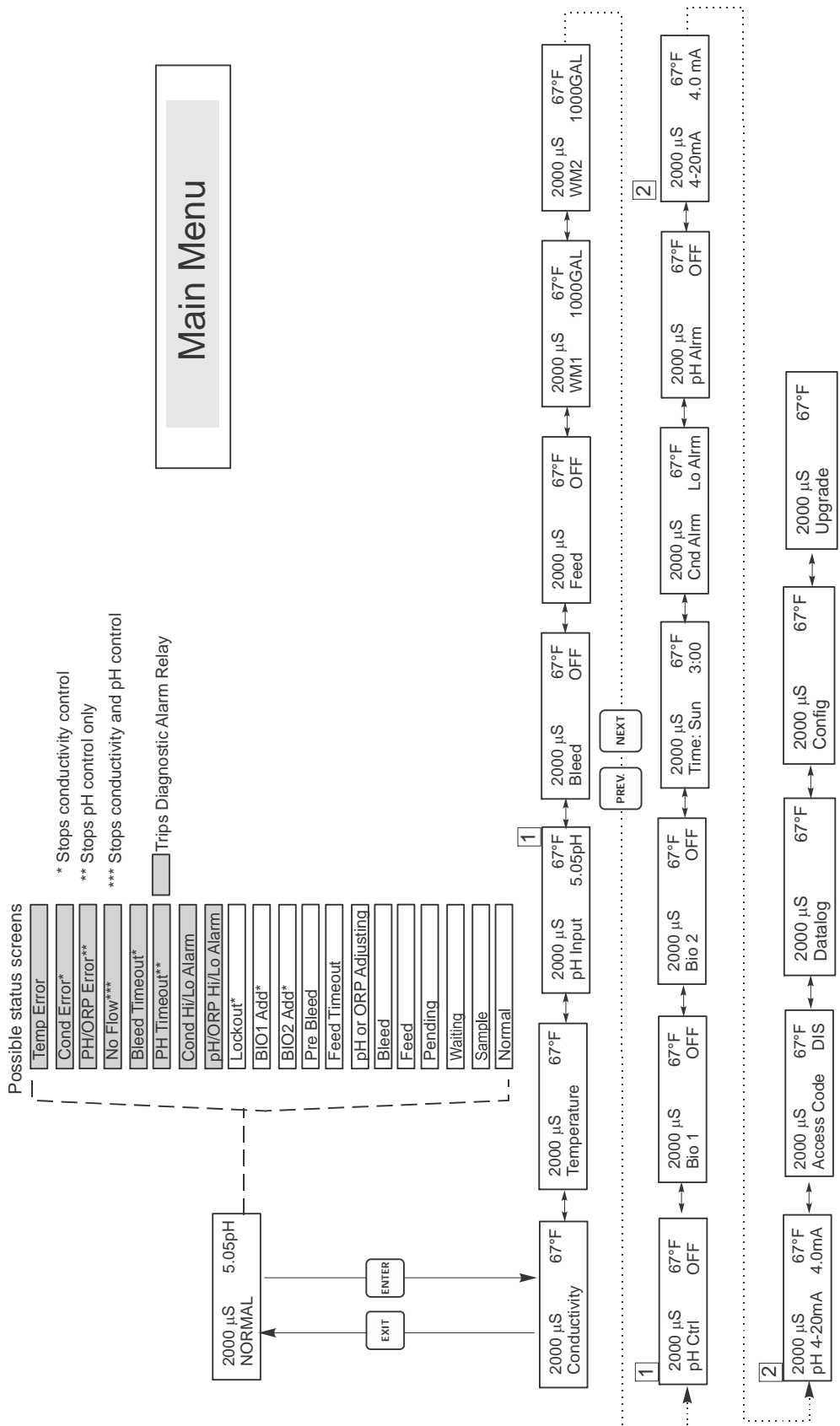
To view the top level menu, press any key. The menu structure is grouped by inputs and outputs. Each input has its own menu for calibration and unit selection as needed. Each output has its own setup menu including set points, timer values and operating modes as needed. After ten minutes of inactivity in the menu, the display will return to the summary display. Keep in mind that even while browsing through menus, the unit is still controlling.

### 5.1 Main Menu

The exact configuration of your WDT410 controller determines which menus are available as you scroll through the settings. See Figure 7 for the Main Menu Chart.

Conductivity	
Temperature	
pH/ORP Input	
Bleed	
Feed	
WM1	
WM2	
pH/ORP Control	
Bio 1	
Bio 2	
Time	
Alarm	
4-20mA	Only if 4-20mA option installed
Access Code	
Datalog	Only if advanced USB feature is in model code
Config	Only if advanced USB feature is in model code
Upgrade	

The NEXT key travels forward through this list while the PREV key travels backwards through the list. Pressing ENTER will Enter the lower level menu that is currently displayed.



## Operation

- Press Enter key to enter menu.
- Press Exit key to exit menu.
- Blinking fields may be edited with the adjust arrows.
- Press Enter when modification is complete to return to Main Menu Level.

## Legend

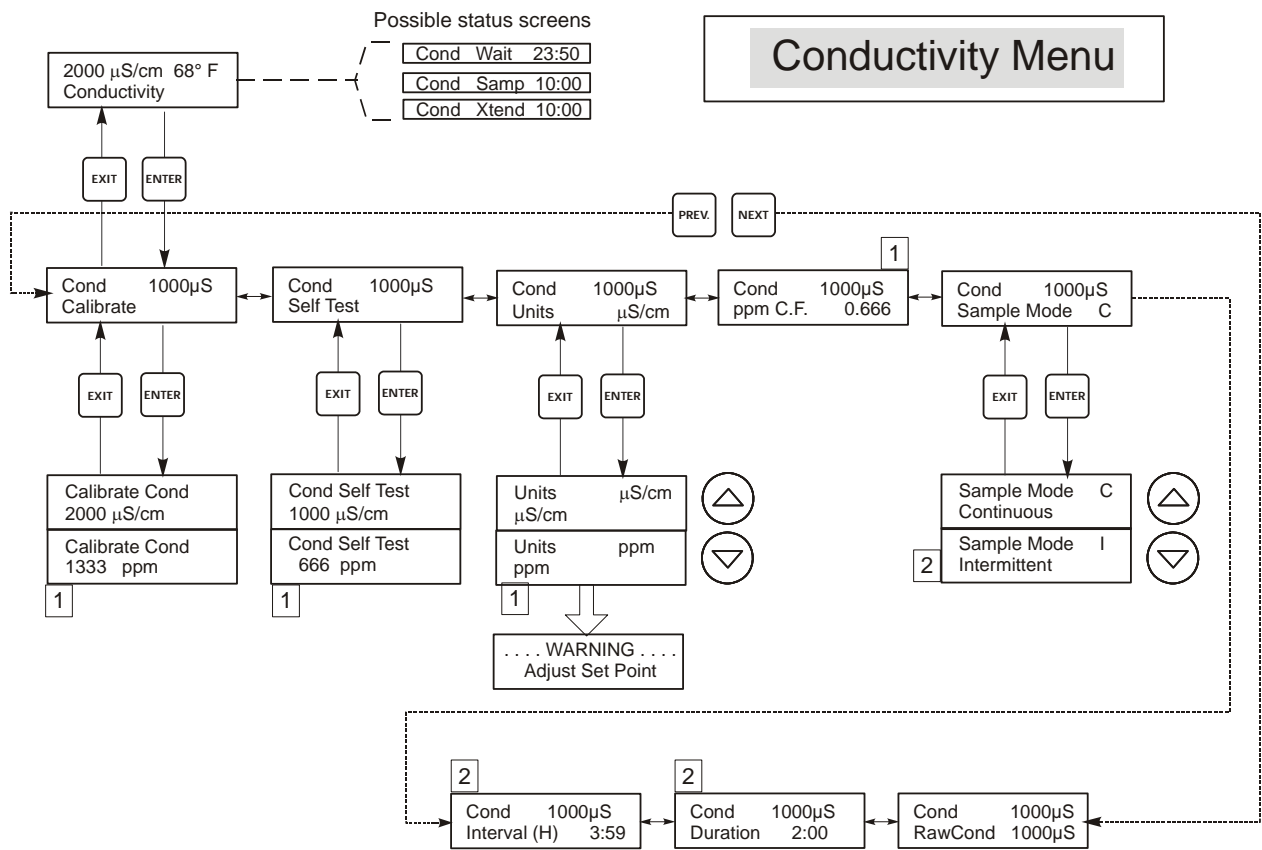
- 1 Menu only appears when pH option board is installed.
- 2 Menu only appears when 4-20 mA hardware is installed.

Figure 7 Main Menu

## 5.2 Conductivity Menu

The conductivity menu provides the following settings: Calibration, Self Test, Unit selection, and sampling mode setup. Additional settings are also discussed below. Refer to figure 8, Conductivity Menu Chart.

<b>Calibrate</b>	To Calibrate the conductivity, use either a hand held meter, or a buffer solution, and adjust the WDT controller to match. Once Calibrate is entered, the unit continuously displays conductivity readings. Press an arrow key to change the value displayed to match the hand held meter or the buffer solution. You must press ENTER to activate the new calibration. You must press the EXIT key to exit calibration. The Bleed output is unaffected until the calibration menu is exited, so if it was ON when you entered calibration it will stay on until you exit.
<b>Self Test</b>	Press ENTER to begin self test. Press any key to stop. Self Test internally simulates a conductivity sensor and should always give the reading $1000 \mu\text{S}/\text{cm} \pm 100 \mu\text{S}$ . If it does not, there is a problem with the electronics and the unit should be serviced. If the self test is in the expected range, and there is a problem calibrating, then the sensor or its wiring is at fault. See Section 7.3 Troubleshooting for details.
<b>Units</b>	You may choose to display conductivity in $\mu\text{S}/\text{cm}$ or in ppm. Press ENTER and then use the Up and Down arrows to change the units. If you change the units, you will be warned to check your settings. This is important. Set points are not automatically translated from $\mu\text{S}/\text{cm}$ to ppm. If you change the units you will need to change your Bleed settings.
<b>ppm C.F.</b>	This is the ppm Conversion Factor (or multiplier). This is typically 0.666 but can be changed to accommodate various requirements.
<b>Sample Mode C / I</b>	Press enter to choose Continuous sampling or Intermittent sampling. A 'C' at the end of the display means that sampling is continuous, while an 'I' indicates intermittent sampling. Use Continuous sampling with a traditional bypass line installation of the conductivity sensor. Choose Intermittent sampling to use the bleed solenoid valve for timed sampling of the conductivity.  Intermittent sampling installations read the conductivity at set intervals for a given sample duration. If the conductivity is above the set point, the valve that controls the sampling will stay open until the conductivity falls below the set point. If the time the valve stays open goes beyond the sample duration, the controller will display Extend on the top status line, as well as the amount of time extended. A limit on this amount of time may be imposed; see Figure 11 Bleed Menu.
	<b>Continuous</b>
	<b>Intermittent</b> If Intermittent sampling is chosen, the Flow Switch input will be ignored, and the following two settings will become available:
<b>Interval</b>	This sets the amount of time between samples. This is set in Hours:Minutes.
<b>Duration</b>	This is the length of each sample. This is set in Minutes:Seconds.
<b>RawCond</b>	This menu is for information only and displays the temperature-compensated conductivity reading before the user's calibration has been applied.



## Legend

- 1 Menu choices that appear when ppm units are selected.
- 2 Menu choices that appear when intermittent sampling is selected.

## Operation

Press Enter key to enter menu.  
 Press Exit key to exit menu.  
 Blinking fields may be edited with the adjust arrows.  
 Press Enter when modification is complete to return to Conductivity Menu Level.

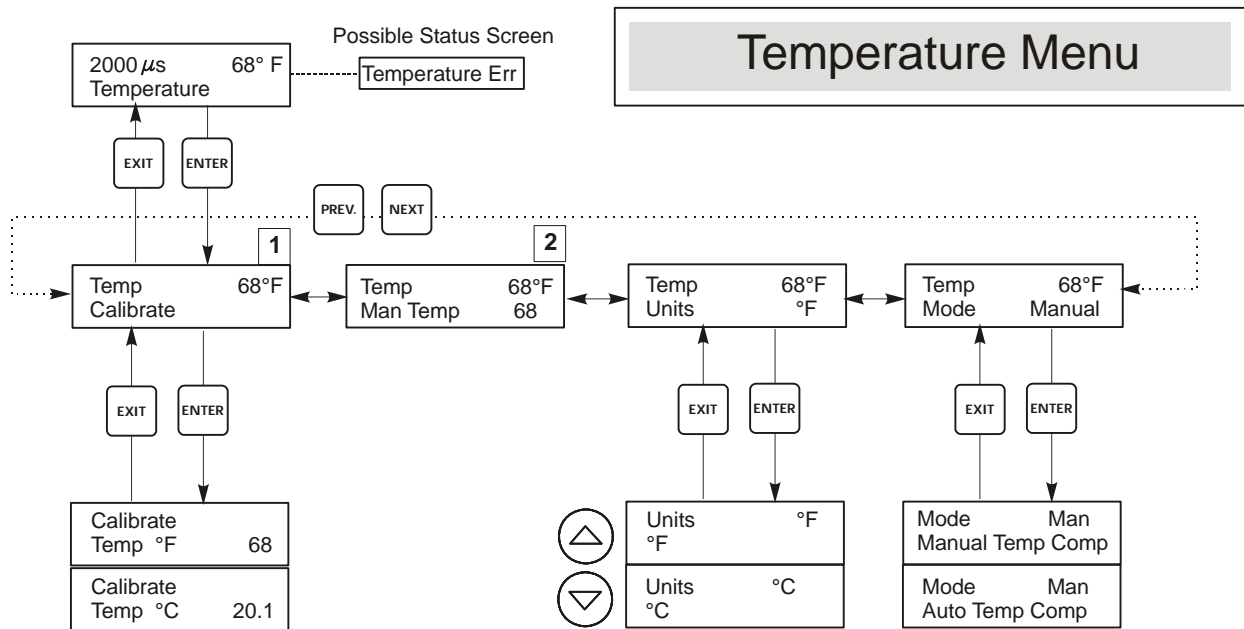
**Figure 8 Conductivity Menu**

### 5.3 Temperature Menu

The Temperature menu contains the following settings: Calibration and Units (if the Temp element is detected when the unit is powered on) or Manual Temp and Units (if no Temp sensor is detected at power up). Refer to the Temperature Menu chart, figure 9.

If a "Temp Error" message appears or if the "Man Temp" menu appears after the unit is powered on, it indicates the temp element is not working properly. Refer to the Troubleshooting Section.

<b>Calibrate</b>	To Calibrate the Temperature, use a thermometer to measure the fluid temperature and adjust the WDT controller to match. Once Calibrate is entered, the unit continuously displays temperature readings. Press the Up or Down arrow key to change the value displayed to match the thermometer. You must press ENTER to activate the new calibration. You must press the EXIT key to exit calibration.
<b>Man Temp</b>	This menu appears only if no temperature element is connected at power-up. Use the arrow keys to adjust the temperature displayed to match that of the water.
<b>Units</b>	You may choose to display temperature in °C or °F. Press ENTER and the Up or Down Arrow keys to change the temperature units for display.
<b>Mode</b>	Press ENTER and use the UP or DOWN arrow keys to select between Manual Temperature Compensation (used with sensors that do not have a temperature measuring element in them) or Automatic Temperature Compensation. If Automatic is selected, and the temperature element is not detected, the controller will display a Temp Error and revert to Manual Temp Comp until the signal is restored.



### Legend

- 1** Menu wording that appears when Automatic Temperature Compensation is selected.
- 2** Menu wording that appears when Manual Temperature Compensation is selected.

**Figure 9 Temperature Menu**

## 5.4 pH/ORP Input Menu

Cal'd	Displays the date of the last electrode calibration.
2 Pt Calibration for pH electrodes	Press the ENTER key to perform a 2 point calibration of the electrode. If using manual temperature compensation, the first display will be:
	<b>Cal Temp °F/C 68</b> Use the arrow keys to enter the actual temperature of the buffer solutions. If using automatic temperature compensation, this display will not appear. Press ENTER to continue.
	<b>Rinse Electrode</b> Remove the electrode from the process and rinse it off. Press ENTER to go to the next step.
	<b>First Buffer</b> This is a prompt to place the electrode in the first buffer. In a few seconds the controller will automatically go to the next step.
	<b>1st Buffer 7.00</b> The bottom line will display "1st Buffer" on the left hand side and "7.00" on the right hand side. Use the arrow keys to set the pH value of the 1st buffer, then press ENTER. The top line will now show the temperature and the mV input from the electrode. The mV will blink until the value is stable. The controller will automatically go onto the next step or you may press ENTER to go to the next step.
	<b>Rinse Electrode</b> Remove the electrode from the buffer and rinse it off. Press ENTER to go to the next step.
	<b>Second Buffer</b> This is a prompt to place the electrode in the second buffer. Again, in a few seconds the controller will automatically go to the next step.
	<b>2nd Buffer 4.00</b> The bottom line will display "2nd Buffer" on the left hand side and "4.00" on the right hand side. Use the arrow keys to set the pH value of the 2nd buffer, then press ENTER. The top line will now show the temperature and the mV input from the electrode. The mV will blink until the value is stable. The controller will automatically go onto the next step or you may press ENTER to go to the next step. The controller will go on to the next step once the mV signal is stable.
	<b>Cal Successful/Cal Failed</b> If the electrode response is good, then the display will read "Cal Successful". If the mV output of the electrode did not change enough between the two buffer solutions, it will read "Cal Failed". A failure usually means that the electrode needs to be cleaned, or replaced. It will also display the % difference from theoretical slope. A failure occurs if the slope is more than 80% different than theoretical.
	<b>Continue Y</b> The controller will hold this display until you replace the electrode in the process and press ENTER. Control will not begin until ENTER is pressed or 10 minutes go by.

Cal'd	<p>Press the ENTER key to perform a 2 point calibration of the electrode. If using manual temperature compensation, the first display will be:</p>
2 Pt Calibration for ORP electrodes	<p><b>Rinse Electrode</b> Remove the electrode from the process and rinse it off. Press ENTER to go to the next step.</p>
	<p><b>First Buffer</b> This is a prompt to place the electrode in the first buffer. In a few seconds the controller will automatically go to the next step.</p>
	<p><b>Input XX mV</b> The display will show the mV reading from the electrode. The entire number will blink until the reading is stable, then the display will change to:</p>
	<p><b>Buffer XX</b> Now you can change the mV value of the buffer, by using the arrow keys and pressing ENTER.</p>
	<p><b>Rinse Electrode</b> Remove the electrode from the buffer and rinse it off. Press ENTER to go to the next step.</p>
	<p><b>Second Buffer</b> This is a prompt to place the electrode in the second buffer. Again, in a few seconds the controller will automatically go to the next step.</p>
	<p><b>Input XXX Mv</b> The display will show the mV reading from the electrode. The entire number will blink until the reading is stable, then the display will change to:</p>
	<p><b>Buffer XXX</b> Now you can change the mV value of the buffer, by using the arrow keys and pressing ENTER.</p>
	<p><b>Cal Successful/Cal Failed</b> If the electrode response is good, then the display will read "Cal Successful". If the mV output of the electrode did not change enough between the two buffer solutions, it will read "Cal Failed". A failure usually means that the electrode needs to be cleaned, or replaced.</p>
	<p><b>Continue Y</b> The controller will hold this display until you replace the electrode in the process and press ENTER. Control will not begin until ENTER is pressed or 10 minutes go by.</p>
1 Pt Calibration for pH electrodes	<p><b>Cal Temp °F/C 68</b> Use the arrow keys to enter the actual temperature of the buffer solutions. Press ENTER to go on to the next step. If using automatic temperature compensation, this display will not appear.</p>
	<p><b>Rinse Electrode</b> Remove the electrode from the process and rinse it off. Press ENTER to go to the next step.</p>
	<p><b>First Buffer</b> This is a prompt to place the electrode in the first buffer. In a few seconds the controller will automatically go to the next step.</p>
	<p><b>Buffer 4.00</b> Use the arrow keys to change the value of the buffer being used, then press ENTER.</p>
	<p><b>1<sup>st</sup> Buffer 4.00</b> The bottom line will display "1st Buffer" on the left hand side and "4.00" on the right hand side. Use the arrow keys to set the pH value of the 1st buffer, then press ENTER. The top line will now show the temperature and the mV input from the electrode. The mV will blink until the value is stable. The controller will automatically go onto the next step or you may press ENTER to go to the next step.</p>
	<p><b>Cal Successful/Cal Failed</b> If the electrode response is good, then the display will read "Cal Successful". If the controller can not calculate an acceptable slope from that mV reading, it will read "Cal Failed". A failure usually means that the electrode needs to be cleaned or replaced.</p>
	<p><b>Continue Y</b> The controller will hold this display until you replace the electrode in the process and press ENTER. Control will not begin until ENTER is pressed or 10 minutes go by.</p>



<b>1 Pt Calibration for ORP electrodes</b>	<b>Rinse Electrode</b> Remove the electrode from the process and rinse it off. Press ENTER to go to the next step.
	<b>First Buffer</b> This is a prompt to place the electrode in the first buffer. In a few seconds the controller will automatically go to the next step.
	<b>Input 96 mV</b> The display will show the mV reading from the electrode. The entire number will blink until the reading is stable, then the display will change to:
	<b>Buffer 96</b> Now you can change the mV value displayed to the known value of the buffer, by using the arrow keys and pressing ENTER.
	<b>Cal Successful/Cal Failed</b> If the electrode response is good, then the display will read "Cal Successful". If the controller can not calculate an acceptable slope from that mV reading, it will read "Cal Failed". A failure usually means that the electrode needs to be cleaned or replaced.
	<b>Continue Y</b> The controller will hold this display until you replace the electrode in the process and press ENTER. Control will not begin until ENTER is pressed or 10 minutes go by.
<b>Days Btwn Cal</b>	Use the arrow keys to set the number of days that you would like to go by before recalibrating the electrode. The controller will prompt you to recalibrate when that time has expired. Setting the number of days to zero will disable this feature.
<b>Input</b>	This menu displays the mV from the electrode. It is useful for troubleshooting.
<b>Self Test</b>	Press ENTER to perform a self-test. If it says "FAIL" in the upper right hand corner, this indicates a problem with the controller which should be returned for repair. If it passes, and you have a problem calibrating, it is an electrode or preamp problem.
<b>Sensor Type</b>	Press ENTER to set up the controller to match the type of electrode to be used. Use the Up and Down arrows to toggle between standard pH, and ORP, then press ENTER to make your selection. The controller will warn you to check your set points, since all set point values will stay the same even though the units of measure may have changed. Press any key to clear the warning messages.

# pH/ORP Input Menu

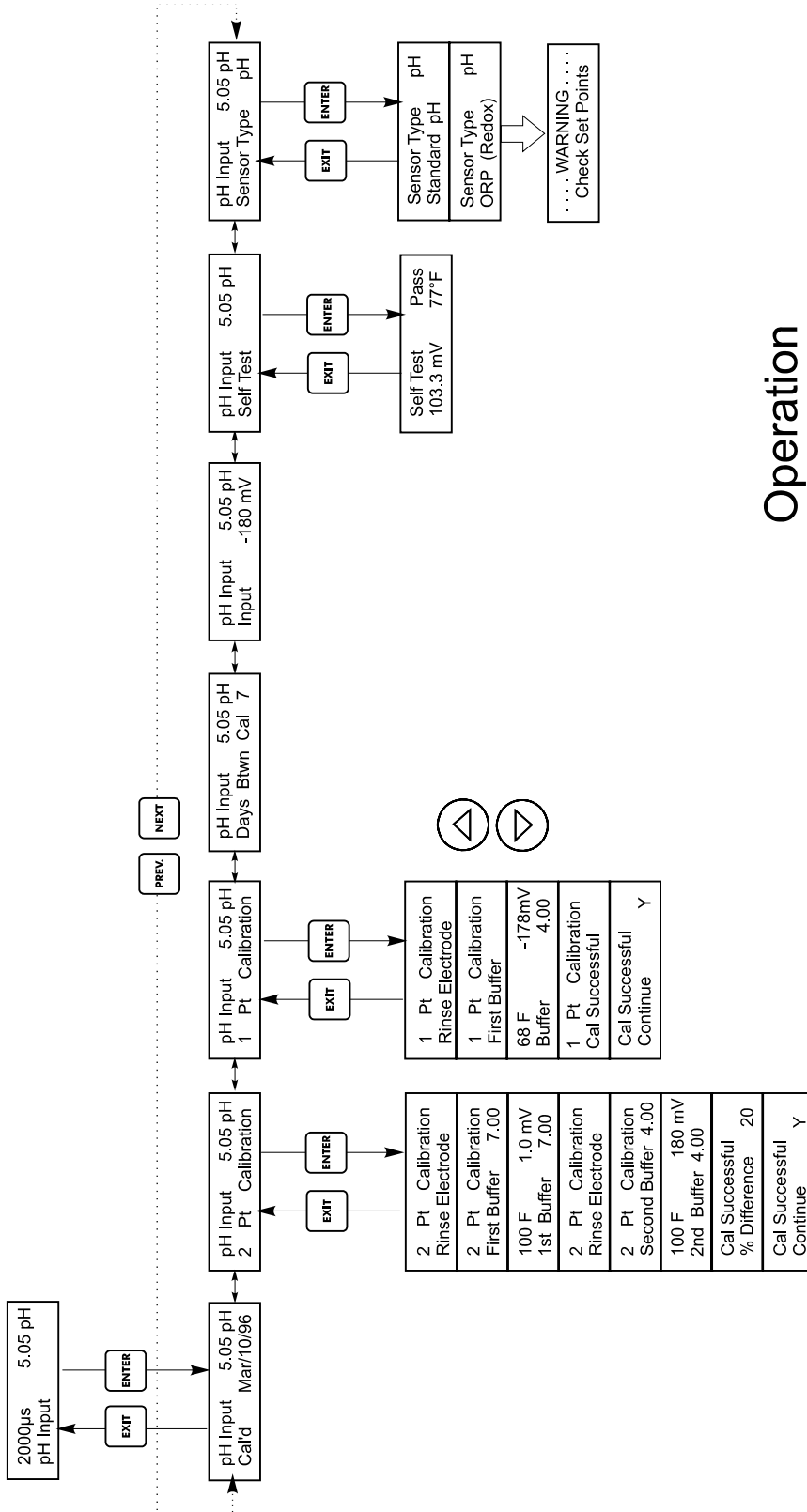


Figure 10 pH/ORP Input Menu

## Operation

Press Enter key to enter menu.  
 Press Exit key to exit menu.  
 Blinking fields may be edited with the adjust arrows.  
 Press Enter when modification is complete to return to Main Menu Level.

Note: Menus are pH or ORP depending on sensor type selected.

## 5.5 Bleed Menu

The Bleed Menu provides the following settings: Set Point, Dead Band, Control Direction, HOA. The Bleed menu will be indicated on the display by one of the following: (The 'A' indicates that the output is being controlled automatically.)

Hint: For easiest programming, program Bleed Mode first, then step through the rest of the feed parameters. The modes are defined as follows:

<b>H</b>	<b>High Set Point</b>	High set point is the default setting, where the bleed relay activates when the conductivity rises above the set point value.
<b>L</b>	<b>Low Set Point</b>	Low set point, or reverse set point, is where the bleed relay activates when the conductivity drops below the set point value.
<b>B</b>	<b>Bleed Volume on Makeup Volume</b>	In bleed volume on makeup volume, a flow of a programmable volume of makeup water triggers the relay to activate, and it stays activated until the bleed water meter detects the programmed volume of water.
Bleed A	<b>OFF</b>	Indicates that the bleed output is currently OFF.
Bleed A	<b>10:00</b>	Indicates the length of time that the Bleed output has been ON.
Bleed A	<b>NO FLOW</b>	Indicates that bleed control has been suspended because there is presently no flow past the flow switch.
Bleed A	<b>LOCKOUT</b>	Indicates that the output is currently locked out due to a biocide add or biocide lockout.
Bleed A	<b>TIMEOUT</b>	Indicates that the bleed output has been on longer than the Time Limit.

<b>Set Point</b>	This is the conductivity value at which the bleed solenoid valve is turned ON. The factory default setting for the WDT controller is for the Bleed output to turn on when the conductivity is higher than the set point. This may be changed at the Control Direction screen.
<b>Dead Band</b>	This is the conductivity value that when combined with the set point determines when the bleed output turns OFF. Assuming that the control direction is set for normal operation (High Set Point) the bleed output will turn off when the conductivity drops below the set point minus the Dead Band. For example: The set point is 1500 $\mu$ S/cm and the Dead Band is 200 $\mu$ S/cm. The bleed output turns ON when the conductivity reading is greater than 1500 but does not turn OFF until the conductivity drops below 1300.
<b>Time Limit</b>	This menu allows you to set a maximum amount of time for the bleed. The limit time is programmed in hours and minutes and can be set between 1 minute and 8 hrs: 20 minutes. If the time limit is set to zero, then the valve may be open indefinitely. If the maximum time is exceeded, the bleed valve will close and will not re-open until the "Reset Timer" menu is reset by an operator.
<b>Reset Timer</b>	Only appears if the time limit above has been exceeded. Use the up or down arrow to change "N" to "Y", then press ENTER.
<b>Bleed Vol</b>	This menu is only displayed if the Bleed Mode is set to BD Vol on MU Vol. Use the arrow keys to select the volume of water to bleed once the relay is triggered.
<b>Makeup Vol</b>	This menu is only displayed if the Bleed Mode is set to BD Vol on MU Vol. Use the arrow keys to select the volume of makeup water required to trigger the bleed relay.
<b>Bleed Mode H / L / B</b>	This menu allows you to set the bleed mode as described above. Press ENTER and then use the Up or Down arrow keys to select between High Set Point, Low Set Point or BD Vol on MU Vol.
<b>H O A</b>	The "Hand Off Auto" screen allows you to select the operating mode of the bleed output. In Hand (manual) mode, the output is turned on immediately for a maximum of 10 minutes. If you walk away the output will return to Auto mode at the end of that time. In Off mode the output will stay Off indefinitely. In Auto mode the bleed output will respond to changes in conductivity based on the set point. The HOA mode of the bleed output is indicated on the bleed status lines.

# Bleed Menu

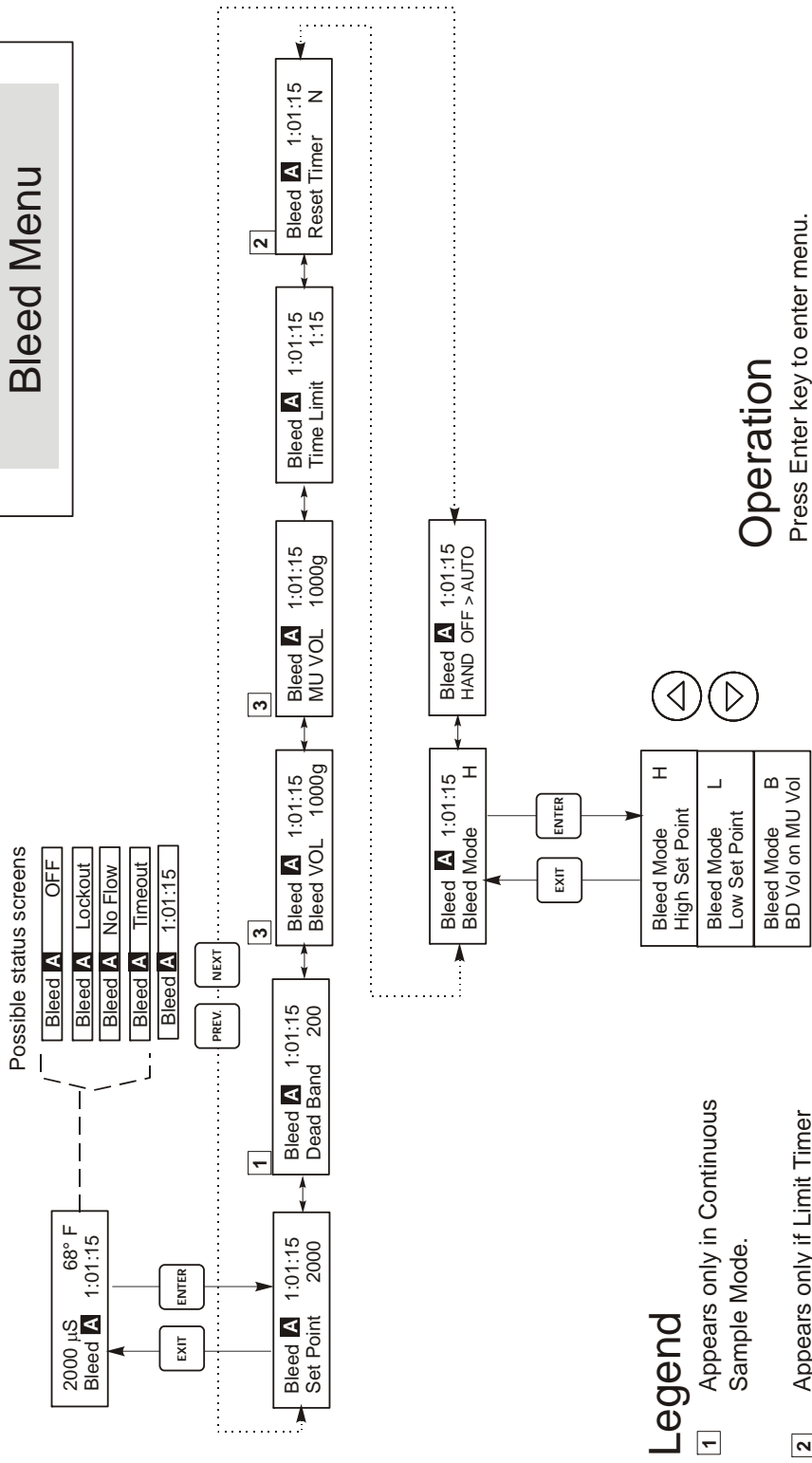


Figure 11 Bleed Menu

## 5.6 Feed Menu

The Feed Menu adapts to the selected Feed output mode.

**Hint: For easiest programming, program Feed Mode first, then step through the rest of the feed parameters.**

The modes are defined as follows:

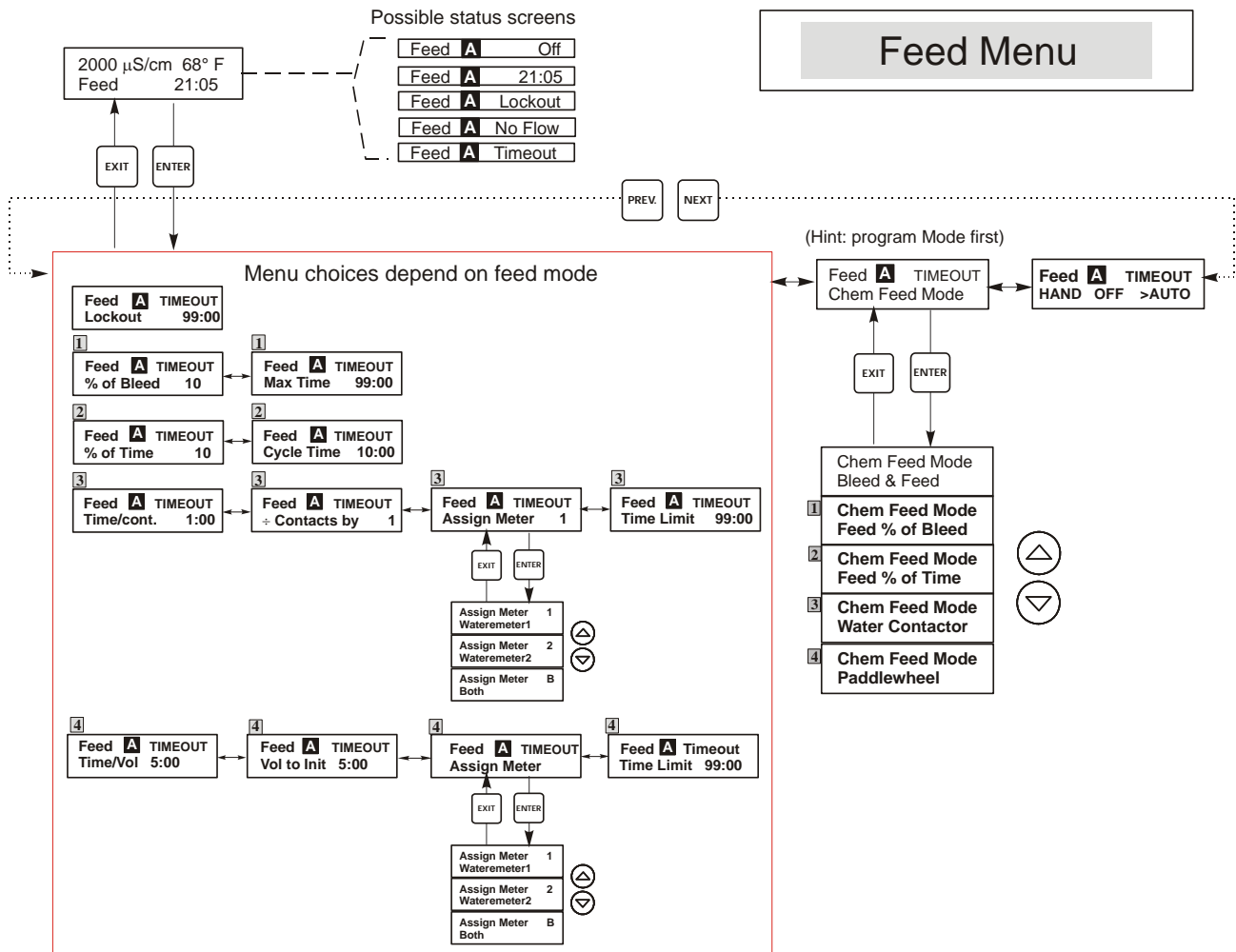
- A      Bleed and Feed with Optional Lockout**      Bleed and Feed Mode turns the Feed output On and Off at the same time as the Bleed output. The lockout setting determines the maximum allowable time for the Feed output. If this time is exceeded the Feed output is turned off and Locked out until the Bleed output turns off.
- B                      Feed % of Bleed**      Feed % of Bleed Mode tracks the length of time that the Bleed output is on. When the bleed turns off the feed output is energized for a user defined proportion of the bleed time.
- C                      Feed % of Time**      Feed % of Time Mode turns on the Feed output for a user definable % of a timed cycle. The time cycle length is adjustable from 10 to 60 minutes.
- D      Feed based on Water Contactor Input**      Feed based on Water Contactor Input Mode turns on the Feed output for a user definable time each time a water contactor pulse is detected. This contactor input can be divided to accommodate a large variety of water meters. Contacts will accumulate feed time so that all contacts are accounted for.
- E      Feed based on Paddlewheel Input Mode**      Turns on the Feed output for a user definable time each time a defined volume of flow is detected. This paddlewheel input has a programmable K Factor to work with a large variety of Hall Effect (square wave, not sine wave) flow meters.

The Feed menu will be indicated on the display by one of the following: (The 'A' indicates that the feed is being controlled automatically.)

- Feed A      **OFF**      Indicates that the Feed output is currently OFF.
- Feed A      **10:00**      Indicates the length of time that the Feed output has been ON or the length of time that the Feed output will be ON.
- Feed A      **NO FLOW**      Indicates that Feed control has been suspended because there is presently no flow past the flow switch.
- Feed A      **TIMEOUT**      Indicates that the feed lockout timer in the Bleed and Feed mode has expired.
- Feed A      **LOCKOUT**      Indicates that the output is currently locked out due to a biocide add or biocide lockout.

<b>Bleed and Feed Mode</b>	<b>Lockout</b> Set this for the Feed Lockout Time. The lockout time is the maximum length of time that the feed output can be on. If the lockout time is set to 0:00, the lockout timer is no longer used and the feed output will be on for as long as the bleed is on.
<b>Feed % of Bleed Mode</b>	<b>% of Bleed</b> This is the % value that is multiplied times the accumulated bleed time to determine how long the feed will be. For example, if the bleed was on for 10 minutes and this setting was 50%, the feed output would be on for 5 minutes.
	<b>Max Time</b> This is similar to the lockout time above in that the feed output will not exceed this maximum length.
<b>Feed % of Time Mode</b>	<b>% of Time</b> This is the % value that is multiplied times the cycle length to determine the length of time that the feed output is ON. If the cycle length were 10 minutes and this setting was 40%, the feed output would be on for 4 minutes, then off for 6 minutes and then repeat the cycle.
	<b>Cycle Time</b> This determines the length of the cycle to be used.

<b>Feed Based on Water Contactor Mode</b>	<b>Time/Cont.</b> (Time per contact.) This determines the length of time that the feed pump should be on for each contact that is received.
	<b>÷ Contacts By</b> This setting allows a divider to be entered. The divider will count actual contacts from the meter until the setting is reached before a contact is considered to be received. For example, if the divider is set to 10 and the Time/Cont is set to 5:00, then the feed output would turn on for 5:00 minutes after 10 contacts were received.
	<b>Assign Meter</b> Press ENTER and then use the Up or Down arrow keys to assign the water meter to be used for controlling this relay. Select between Watermeter 1, Watermeter 2, and Both.
	<b>Time Limit</b> This setting puts a limit on the amount of time that can be accumulated by the water meter input. Once this setting has been reached, all contacts will be ignored until the accumulated feed time expires. By setting Time Limit = Time/Cont., the accumulation of contacts can be disabled.
<b>Feed Based on Paddlewheel Mode</b>	<b>Time/Vol</b> This setting determines the pump on-time once a given volume of water has passed through the paddlewheel sensor. The volume required to initiate feed is set below.
	<b>Vol to Init.</b> This setting determines the volume of makeup water that will initiate chemical feed.
	<b>Assign Meter</b> Press ENTER and then use the Up or Down arrow keys to assign the water meter to be used for controlling this relay. Select between Watermeter 1, Watermeter 2, and Both.
	<b>Time Limit</b> This setting puts a limit on the amount of time that can be accumulated by the water meter input. Once this setting has been reached, all contacts will be ignored until the accumulated feed time expires. By setting Time Limit = Time/Vol., the accumulation of contacts can be disabled. This is set in minutes and seconds. The following settings are for all feed modes.
<b>Chem Feed Mode A/B/C/D/E</b>	This allows the user to select the chemical feed mode as described above.
<b>H O A</b>	This sets the Hand Off Auto for the feed output. This was explained in the Bleed Menu section and functions similarly. In Off position, the output will not turn ON regardless of the feed mode selected.



## Legend

- ① Menu choices that appear when Feed as % of Bleed mode is selected.
- ② Menu choices that appear when Feed as % of Time mode is selected.
- ③ Menu choices that appear when Feed based on Water contactor input is selected.
- ④ Menu choices that appear when Feed based on Paddlewheel input is selected.

## Operation

Press Enter key to enter menu.  
 Press Exit key to exit menu.  
 Blinking fields may be edited with the adjust arrows.  
 Press Enter when modification is complete to return to Feed Menu Level.  
 Press Enter or Adjust arrow to turn on/off output at Hand menu.

Figure 12 Feed Menu

## 5.7 WM1 and WM2 Menus

The Water Meter 1 and 2 menus are used to set up the type of meter and how to convert the water meter signal into volume. The Water Meter menus will be indicated on the display as follows:

WM1 100 Gal or Liters

<b>Reset Totalizer N</b>	This allows you to restart the totalizer display. Press the Up or Down arrow key to change the N to Y and press ENTER to reset the totalizer to 0 gal. The totalizer will count up to a maximum of 99,999,999. After that it will reset itself to zero.
<b>Vol/cont</b> Only appears if the WM Type mode is Water contactor.	This allows you to set the volume of makeup per contact from the water meter.
<b>K Factor</b> Only appears if the WM Type mode is Paddlewheel	Enter the number of pulses per unit volume that the paddlewheel sensor sends out. This value is usually printed on the sensor's flow cell or in its instructions.
<b>Tot Units</b>	This is used to set the units of measure for the totalizer. Press ENTER, then use the up and down arrow keys to toggle between "Gallons" and "Liters." Press ENTER when the desired choice is displayed.
<b>WM Type</b>	Press ENTER and then use the Up or Down arrow keys to select between Water Contactor, Paddlewheel, or Not Used.

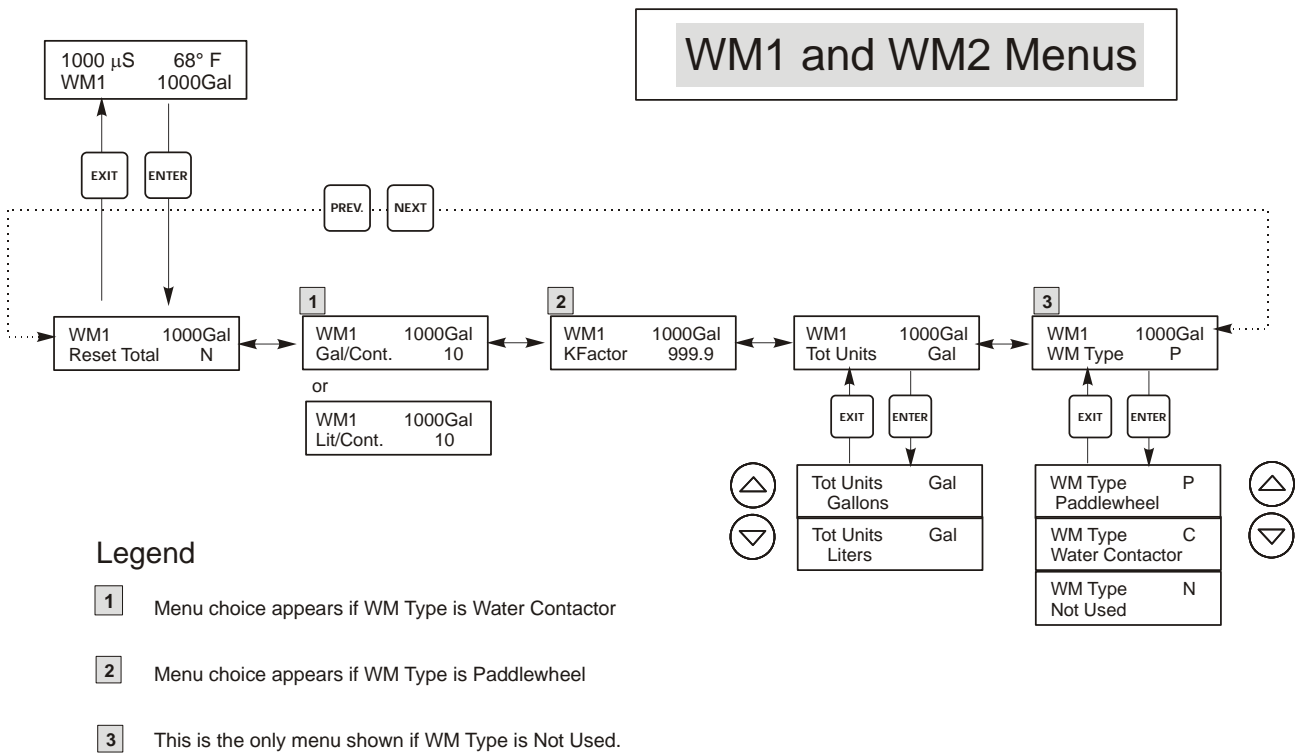


Figure 13 WM1 and WM2 Menus



## 5.8 pH/ORP Control Menu

The pH/ORP Control Menu provides the following independent settings: Set Point, Dead Band, Time Limit, Control Direction, and HOA.

The top level menu status line may display the following messages: Off, Intrlck, Timeout, or a time. "Off" indicates that the output is off. "Intrclck" indicates that a signal from a flow switch or level switch is stopping control and has disabled the control outputs. "Timeout" indicates that the output has been on for longer than the maximum time programmed by the user. The time shows that the output is on, and has been for that amount of time. Refer to the pH/ORP Ctrl menu on the following page. Note: To see the set points in mV instead of pH, first go to the pH/ORP input menu and set the Sensor Type to ORP.

<b>Set Point</b>	Use the arrow keys to adjust the display to read the desired set point value. Press ENTER to accept the change.	
<b>Dead Band</b>	Use the arrow keys to set the desired dead band, then press ENTER. If the set point is pH 7.00, and the dead band is 0.05 pH units, then the relay will close at pH 7.00 and open 0.05 pH units away from 7.00.	
<b>Time Limit</b>	Use the arrow keys to set the time limit for the output to be active, then press ENTER. The time limit is set in the format "H:MM". If it is set for "0:00", no limit will be imposed, and the output could stay on forever.	
<b>Control Dir</b>	Press ENTER to change the direction of control, then use the Up and Down arrows to toggle between High Set Point and Low Set Point, and press ENTER to make your choice. A high set point will turn on the relay when the process value goes over the set point value (to add an acid, or reducing agent, or as a high alarm). A low set point will turn on the relay when the process value goes below the set point value (to add an alkali, or oxidizer, or as a low alarm).	
	<b>High Set Point</b>	<b>Low Set Point</b>
<b>HOA</b>	Use the Left and Right arrows to move between Hand, Off and Auto. In Hand (Manual) mode, the output will be turned on immediately for a maximum of 10 minutes. In the Off mode, the output will be turned off indefinitely. In the Auto mode, the output turns on and off in response to changes in the process value relative to the set point. The letter inside the block on the status screen indicates which mode the output is in.	

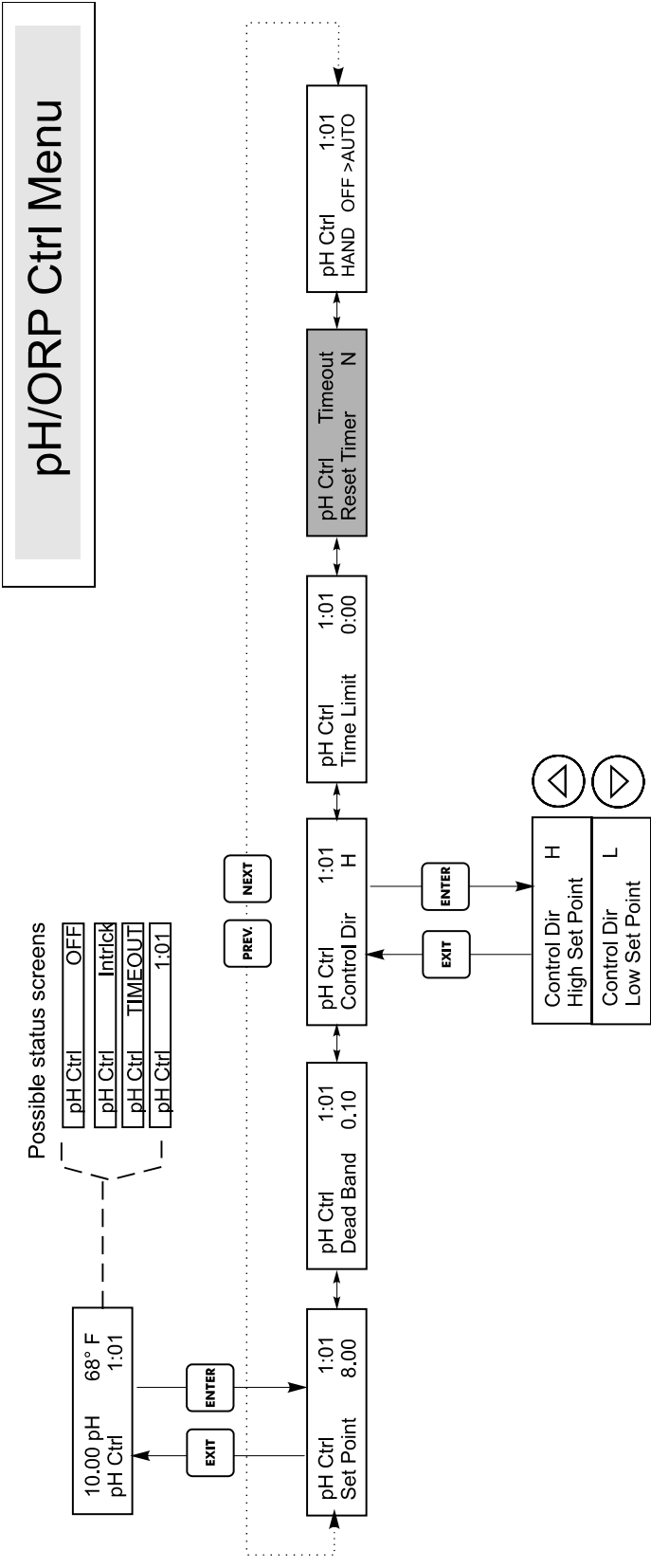


Figure 14 pH/ORP Control Menu

## Operation

Press Enter key to enter menu.  
 Press Exit key to exit menu.  
 Blinking fields may be edited with the adjust arrows.  
 Press Enter when modification is complete to return to Main Menu Level.

## Legend

Menu appears when pH Timeout has occurred.

Note: Menus are either pH or ORP depending on sensor type selected in pH/ORP Input Menu.

## 5.9 Bio1 and Bio2 Menus

The Bio 1 and Bio 2 menus are separate from each other but operate in exactly the same way. Each menu provides the following independent settings: Prog Bio Adds, Bio Pre-Bleed, Bio Lockout Time, Set Bio Mode, HOA. Bio menus may display the following screens:

Bio 1 A	<b>OFF</b>	Indicates that the Bio 1 output is off.
Bio 1 A	<b>PENDING</b>	Indicates that Bio 1 is ready to begin a biocide cycle but is unable to begin due to NO FLOW, or Bio 2 already ON.
Bio 1 A	<b>PRE BLD</b>	Indicates that Bio 1 is in the Pre-Bleed portion of its cycle.
Bio 1 A	<b>4:50</b>	Indicates that Bio 1 is adding and has 4 minutes and 50 seconds remaining to add, or that there are 4 hours and 50 minutes of Bio 1 Lockout remaining. If the Bio 1 LED is ON, the timer is for the Add. If the LED is OFF, the timer is for remaining lockout time.
Bio 1 A	<b>NO FLOW</b>	Indicates that there is no biocide activity and none is pending and that there is no flow past the flow switch.

Note: When programming for the first time, set the Biocide Add mode first.

A number of built-in interlocks are part of the biocide feed program. When one biocide relay activates, the other biocide will be locked out until the first biocide finishes its control cycle. Similarly, the bleed relay is locked out once the biocide cycle begins (except for the pre-bleed portion of the cycle). Bear this in mind, especially if the biocide feed time is very long or very frequent...very little time is left in the day to control the conductivity.

The inhibitor feed relay interaction is more complex:

<b>For Bleed and Feed mode</b>	Since the bleed relay is locked out, the feed relay will be locked out as well.
<b>For Feed as % Bleed</b>	If the bleed is adjacent to the start of the biocide cycle, or is during the pre-bleed part of the cycle, the feed time does not occur.
<b>For Feed as % Time</b>	The feed relay is locked out during the biocide add, the feed events are not stored in memory, but the feed cycle time is reset once the biocide add cycle is over, so that as soon as the biocide cycle is complete, one feed cycle will occur.
<b>For Water Contactor or Paddlewheel mode</b>	The water flow is stored in memory, up to 256 contacts, and the correct feed time is activated once the biocide cycle has completed.

<p><b>Prog Bio 1 Add</b></p>	<p>Press ENTER here to see a list of all of the biocide adds presently scheduled. The first screen displayed is for Today's Biocide add. Use the NEXT key to see Tomorrow's add or the PREV key to see Yesterday's add. Use the arrow keys to edit the starting time or length of the add. The screen should look similar to the one below:</p> <pre style="margin-left: 40px;">Prog Bio 1 Add 2Mon 10:00 45</pre> <p>The bottom line indicates that on the second Monday in a multi-week cycle, Bio 1 will begin its Biocide Addition cycle at 10 AM and will add for 45 minutes. If the biocide output does not come on at exactly 10 AM, there may be NO FLOW, or there may be a conflict with Biocide output 2. If either of these conditions is true, the output will be delayed until the flow has been restored, or the Biocide 2 lockout time is completed. The times are set in a 24 hour format, so 1 PM is entered as 13:00. The WDT supports daily cycles, 1 week cycles, 2 week cycles and 4 week cycles. It is not necessary for both biocide outputs to be on the same cycle.</p> <p>Press the EXIT key to exit the Prog Bio 1 menu. There are separate Bio 1 and Bio 2 Program menus and separate program memories, allowing addition of each biocide independently.</p>							
<p><b>Pre Bleed</b></p>	<p>This setting provides a Pre Biocide Add Bleed Conductivity Set Point. Pre Bleed is the first step in a biocide addition. The operating conductivity must be lower than this setting before the biocide output will turn ON. If the conductivity is higher than this set point, the bleed output is turned on to lower the conductivity. This setting is independent of the bleed set point in the Bleed Menu. There are separate Bio 1 and Bio 2 Pre Bleed settings. To disable the Pre Bleed, set this value higher than your operating set point or set the value to zero.</p>							
<p><b>Lockout</b></p>	<p>This setting determines how long bleed and additional biocide adds will be locked out after completing a biocide add. This value is set in hours and minutes. There are separate Bio 1 and Bio 2 settings. This can be set to 0 if it is not desired.</p>							
<p><b>Bio 1 Add Mode 1</b></p>	<p>The last digit indicates that Bio 1 adds are scheduled on a 1 week repeating cycle. To change this, press the ENTER key and then use the Up or Down arrow keys to select the appropriate choice. Biocide cycles may be daily (up to ten times per day) or 1, 2, or 4 weeks long. This is provided to save you some programming effort. If you add the same thing every week, use the 1 week cycle. If you wish to add Biocide 1 only once every two or four weeks use the 2 or 4 week cycle. If you wish to add Biocide 1 more than once a day, choose the daily cycle.</p> <p>The Bio 1 cycle length is not affected by the Bio 2 cycle length. In weekly cycle modes, the WDT can schedule one add per day for each Biocide output for up to 4 weeks. If a daily cycle is chosen, that biocide can be added up to ten times per day, every day.</p> <table border="1" data-bbox="570 1045 1466 1087" style="width: 100%; text-align: center;"> <tr> <td style="width: 25%;">1 Week</td> <td style="width: 25%;">2 Week</td> <td style="width: 25%;">4 Week</td> <td style="width: 25%;">Daily</td> </tr> </table>				1 Week	2 Week	4 Week	Daily
1 Week	2 Week	4 Week	Daily					
<p><b>H O A</b></p>	<p>This is the Hand Off Auto selector screen for the Biocide output. There are separate settings for Bio 1 and Bio 2. <u>In the Off position Biocide adds can be missed.</u> See the description in the Bleed menu for more details about HOA settings.</p>							

# Biocide 1 Menu

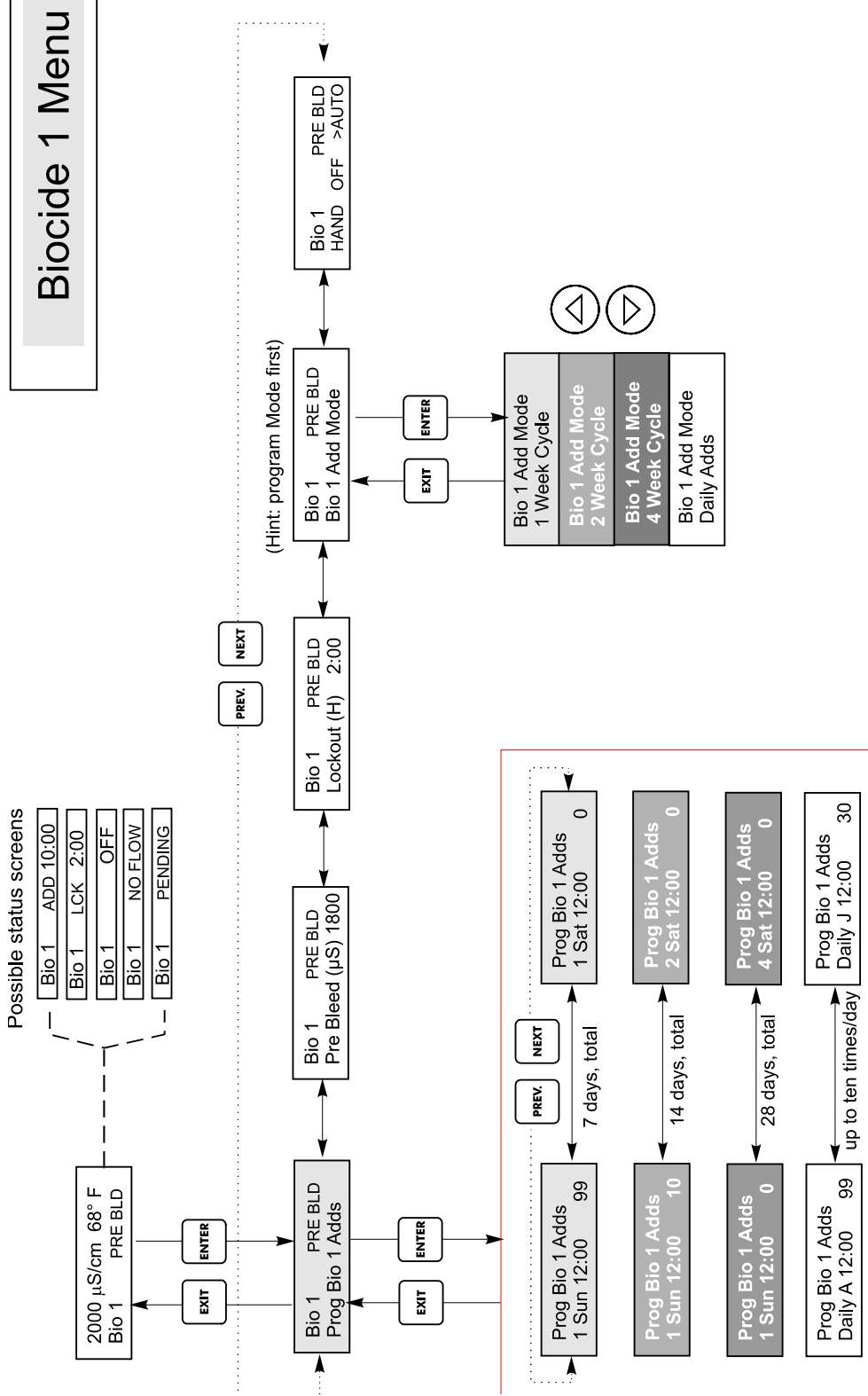


Figure 15 Biocide 1 Menu

## Operation

- Press Enter key to enter menu.
- Press Exit key to exit menu.
- Blinking fields may be edited with the adjust arrows.
- Press Enter when modification is complete.
- Use Next and Prev keys to change days in Prog.

## Legend

- Menu choices that appear when 1 Week Biocide Cycle mode is selected.
- Menu choices that appear when 2 Week Biocide Cycle mode is selected.
- Menu choices that appear when 4 Week Biocide Cycle mode is selected.

# Biocide 2 Menu

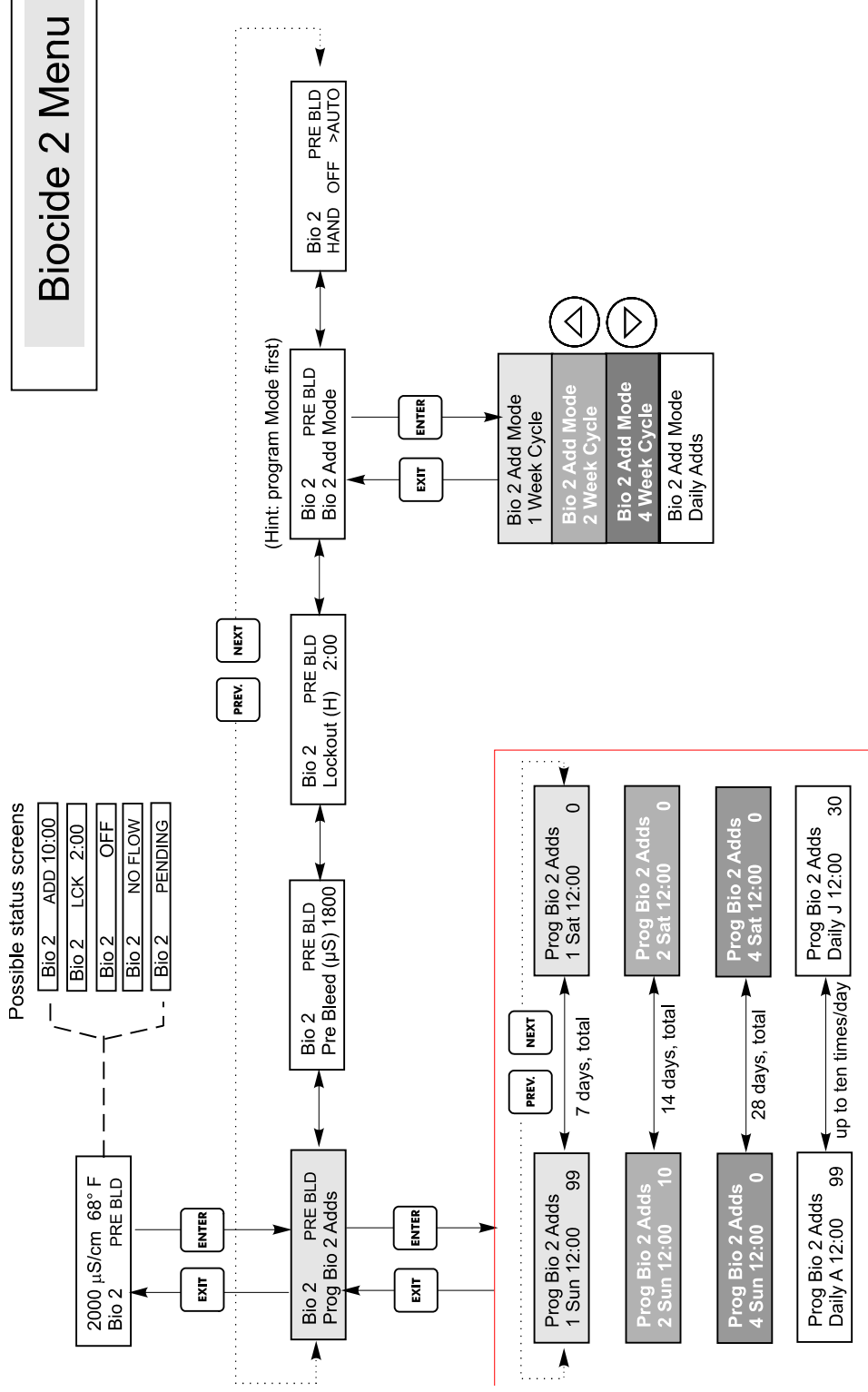


Figure 16 Biocide 2 Menu

## Operation

- Press Enter key to enter menu.
- Press Exit key to exit menu.
- Blinking fields may be edited with the adjust arrows.
- Press Enter when modification is complete.
- Use Next and Prev keys to change days in Prog.

## 5.10 Time Menu

This menu has only one choice, to set the Time used for Biocide adds or Datalogs. This menu will appear as follows:

Time: 2Mon 10:20

Set Time	Press ENTER to set the Time. Use the arrow keys to adjust the day and time and then press ENTER to store or EXIT to discard. If either biocide is set for a 2 or 4 week cycle, you can change the current week in the cycle by changing the week number. If the longest biocide cycle is 2 weeks, the 3Sun through 4Sat choices are not shown.
----------	--

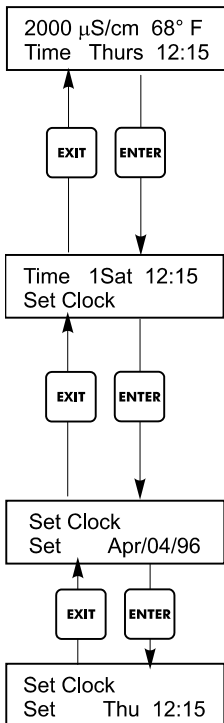


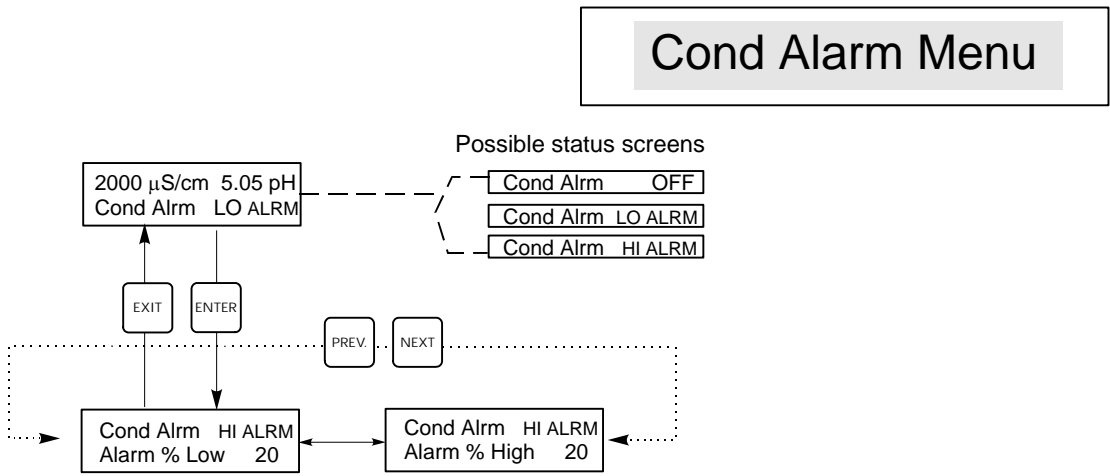
Figure 17 Time Menu

## 5.11 Cond Alarm Menu

The Cond Alarm menu screen will appear as follows:

Cond Alrm OFF  
 Cond Alrm LOW ALRM  
 Cond Alrm HI ALRM

<b>Set % Low</b>	This is the % below the bleed set point that the LOW ALARM will activate. If the conductivity set point is 1000 and the % Low setting is 20 then the Low alarm will activate at 800. The alarm can be disabled by setting it to zero.
<b>Set % High</b>	This is the % above the bleed set point that the HIGH ALARM will activate. If the conductivity set point is 1000 and the % High setting is 20 then the High alarm will activate at 1200. The alarm can be disabled by setting it to zero.



**Figure 18 Cond Alarm Menu**

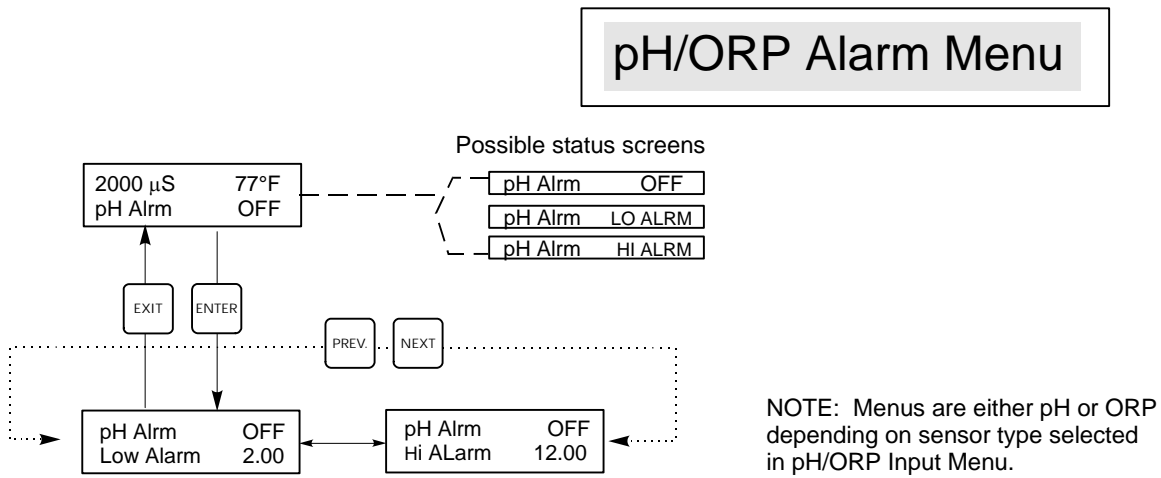


## 5.12 pH/ORP Alarm Menu

The pH Alarm menu screen will appear as follows:

pH Alrm OFF  
 pH Alrm LOW ALRM  
 pH Alrm HI ALRM

<b>Low Alarm</b>	This is the pH/ORP setting below which will produce a pH/ORP Lo Alarm indication on the main status screen. The alarm can be disabled by setting it to zero.
<b>Hi Alarm</b>	This is the pH/ORP setting above which will produce a pH/ORP Hi Alarm indication on the main status screen. The alarm can be disabled by setting it to zero.



**Figure 19 pH/ORP Alarm Menu**

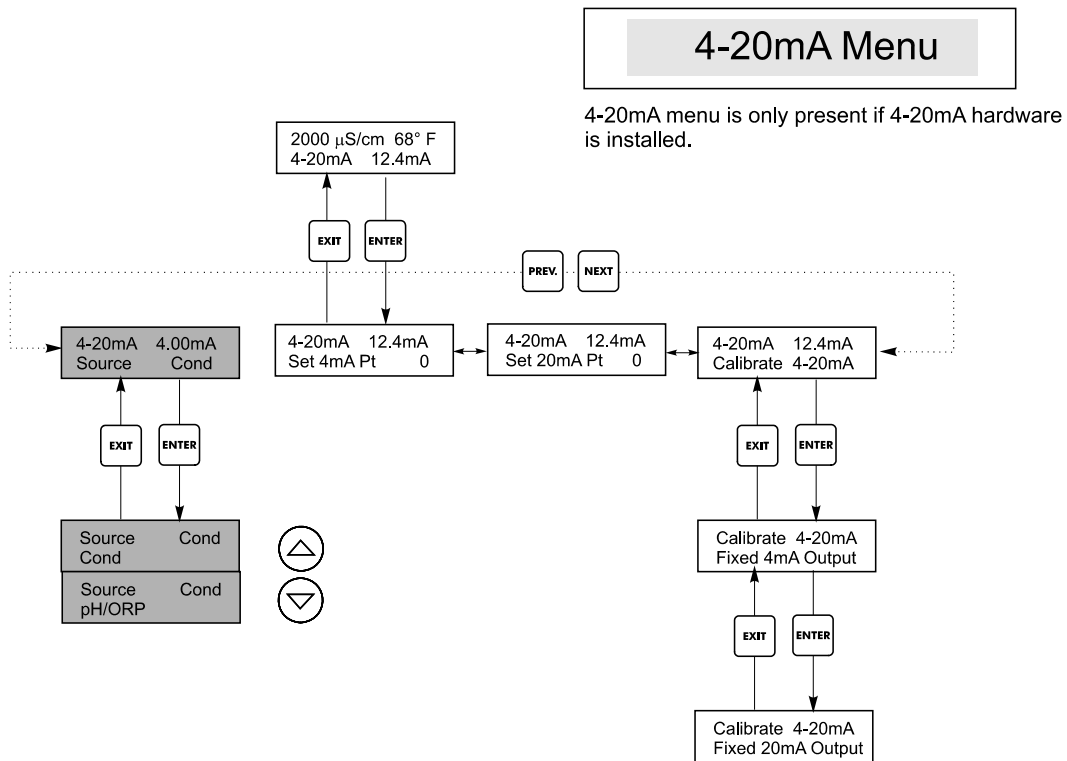
### 5.13 4-20mA Menu (Optional)

This menu is only available if the optional 4-20mA output board(s) is (are) installed in the controller. This menu provides for scaling and calibrating the output. The 4-20mA menu screen appears as follows:

4-20mA 9.20mA

This indicates that the current output of the 4-20mA card is 9.20 mA.

<b>Set 4mA Pt</b>	This conductivity setting will correspond to a 4 mA output from the controller.
<b>Set 20mA Pt</b>	This conductivity setting will correspond to a 20mA output from the controller.
<b>Calibrate</b>	This will provide fixed 4mA and fixed 20mA outputs to allow you to calibrate connected equipment.
<b>Source</b>	This menu allows the user to designate what measurement (pH/ORP or Cond) is mapped to the 4-20 mA output. It only appears if a second 4-20 mA option board is not installed on the pH option board. When both are present, this menu is not present and the 4-20 mA output is assigned to conductivity.



#### Legend

Only appears if one (1) 4-20 mA option board is installed on lower power supply board.

#### Operation

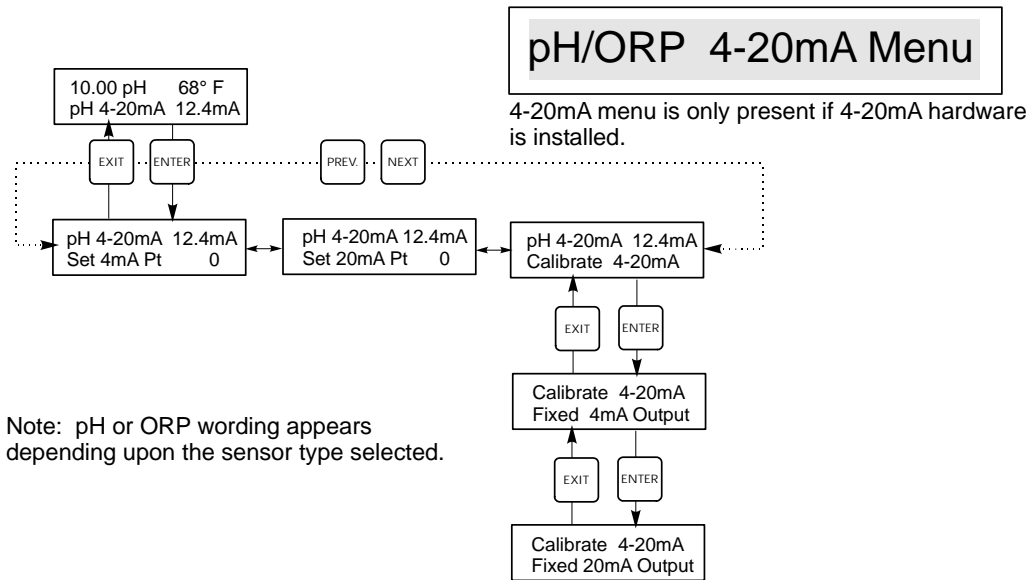
Press Enter key to enter menu.  
 Press Exit key to exit menu.  
 Blinking fields may be edited with the adjust arrows.  
 Press Enter when modification is complete to return to Main Menu Level

**Figure 20 4-20mA Menu**

## 5.14 pH/ORP 4-20mA Menu (Optional)

This menu will only appear if the optional 4-20mA output board is installed on the pH input board. It is used to set the scale of the 4-20 mA output. It contains the following menu selections: 4 mA Point, 20 mA Point and Calibrate.

<b>4mA Pt</b>	Use the arrow keys to enter the process value (in either pH units or mV if ORP) that you want to correspond to a 4 mA output from the controller.
<b>20mA Pt</b>	Use the arrow keys to enter the process value (in either pH units or mV if ORP) that you want to correspond to a 20 mA output from the controller.
<b>Calibrate</b>	This menu is used to calibrate instruments connected to the mA output. The 4-20 mA output is extremely accurate and stable and therefore will never need calibration. This feature allows other devices to be calibrated at the 4 and 20 mA points. Press ENTER to start the calibration.
	<b>Fixed 4 mA Out</b> The controller will output 4.00 mA. Adjust the chart recorder or data logger per its instruction so that the process value displayed is what is expected for a 4.00 mA input.
	<b>Fixed 20 mA Out</b> As above, except that the controller will output 20.00 mA. The design of the 4-20 mA output is such that it should never need calibration. If the mA signal is not what it should be, call the factory for service.



**Figure 21 pH/ORP 4-20mA Menu**

## 5.15 Access Code Menu

This menu determines whether the access code feature of the controller is enabled or disabled and allows you to customize the access code to your own value. The access code controls whether or not you are allowed to change the parameters in the controller. With the access code disabled, any user may change any parameter. With the access code enabled, any user can view any parameter, but cannot change them. Once an attempt is made to change a parameter, the display will prompt the user to enter the access code. If the correct access code is entered, the parameters can be changed. If the wrong access code is entered the parameters cannot be changed. Once the access code has been correctly entered, it will remain valid until there is a period of 10 minutes without a key being pressed.

The access code menu will appear as shown below:

Access Code	<b>DIS</b>	Indicates that the access code is disabled. No access code is required to change any setting.
Access Code	<b>REQ</b>	Indicates that the access code is required to alter settings.
Access Code	<b>OK</b>	Indicates that the access code is required and has been entered correctly.

<b>Enable N / Y</b>	Press the Up or Down arrow key to change the N to Y and press ENTER to enable the access code feature. If the access code is enabled you must first enter the access code to disable it.
<b>New Value</b>	<p>Press ENTER to display the current access code value and use the arrow keys to change it to any value between 0 and 9999. If the access code has been enabled, you will be prompted to enter the current access code before being allowed to change it. You must remember the access code if you enable it.</p> <p>The Factory default Access code is 1995.</p> <p>If you change the access code and can't remember it follow this procedure:</p> <ol style="list-style-type: none"> <li>1. Turn off power to the controller.</li> <li>2. Wait 10 seconds.</li> <li>3. Press and Hold the UP and DOWN arrow keys while turning on the power.</li> <li>4. Read the access code on the display.</li> <li>5. Release the keys, and the access code will disappear.</li> </ol>

### Access Code Menu

Any Top Display  
Access Code 0000

The Access Code prompt may appear at any screen in the entire menu structure if the current access code has not been entered by the user. Access code entries will be valid for 10 minutes from the most recent key press.

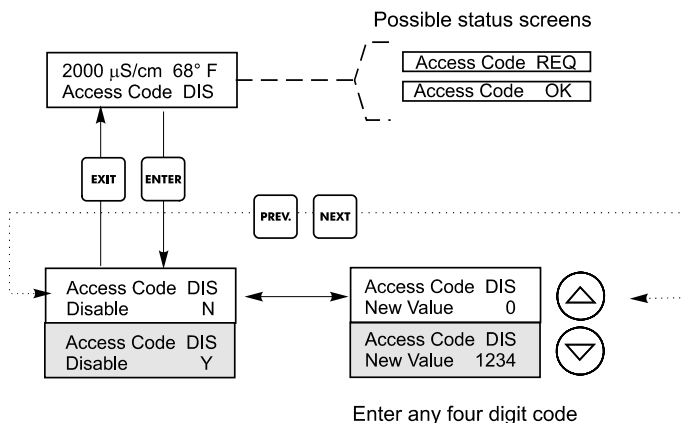


Figure 22 Access Code Menu

## 5.16 Datalog Menu

This menu is available if the data logging option has been purchased. This is indicated in the model code by the letter U at the end of the model code. This menu allows you to save data from the controller to a USB flash drive.

The controller has four logs, the Current Datalog, the Backup Datalog, the Event Log, and the Reset Log. All files are in a CSV format that may be opened in a spreadsheet such as Microsoft Excel.

**Current Datalog** Contains the following data taken at 10 minute intervals:

- Conductivity
- Temperature
- pH or ORP
- Water Meter 1 Total
- Water Meter 2 Total

When the current datalog is downloaded to a USB stick, it is erased and a new log file is started.

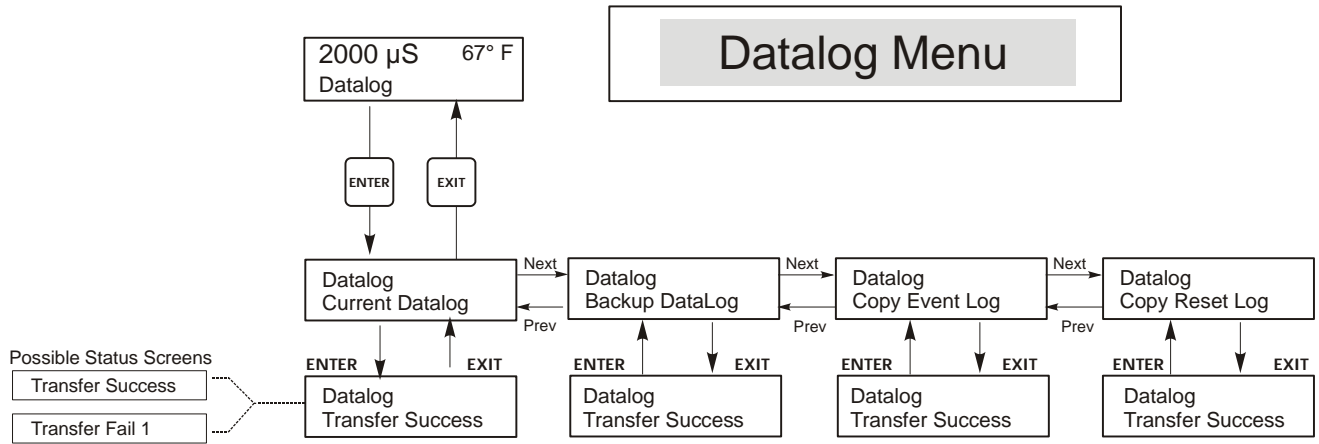
If the current datalog is not downloaded before it reaches its maximum size (at least 60 days of data) the oldest data is overwritten by the newest data.

**Backup Datalog** Contains the same data as the current log but it is never erased. When the backup log reaches its maximum size (at least 60 days of data), the oldest data is overwritten by the newest data.

**Event Log** Contains columns for each relay and flow switch input, as well as the date and time. Each time any of these change state, the date and time is updated and it will show a 1 if the relay is on and 0 if it is off, and a 1 if the flow switch indicates no flow, 0 if there is flow. Tens of thousands of events will be recorded before the oldest data is overwritten by the newest, the number varying with the controller's configuration.

**Reset Log** Consists of time stamps of when power was lost, when it was returned, and the cause of the reset.

<p><b>Current or Backup Datalog</b></p>	<p>Place a USB flash drive with at least 10 MB capacity into the USB port on the front panel of the controller. Press the Enter key to download the file from the controller to the disk. The file name for the Current Datalog will be Datalog&lt;serial number&gt;&lt;date&gt;&lt;time&gt;.csv using the date and time it was downloaded. The file name for the Backup Datalog will be Datalog&lt;serial number&gt;&lt;date&gt;&lt;time&gt;.csv using the date and time it was created.</p> <p>The controller will display the progress of the file download process. If the file was successfully copied to the USB disk the controller will display Transfer Success.</p>	
<p><b>Copy Event Log</b></p>	<p>Place a USB flash drive with at least 10 MB capacity into the USB port on the front panel of the controller. Press the Enter key to download the file from the controller to the stick. The file name will be Eventlog&lt;serial number&gt;&lt;date&gt;&lt;time&gt;.csv.</p> <p>The controller will display the progress of the file download process. If the file was successfully copied to the USB disk the controller will display Transfer Success, otherwise Transfer Fail 1.</p>	
<p><b>Copy Reset Log</b></p>	<p>Transfer Success</p>	<p>Transfer Fail 1</p>
	<p>Transfer Success</p>	<p>Transfer Fail 1</p>

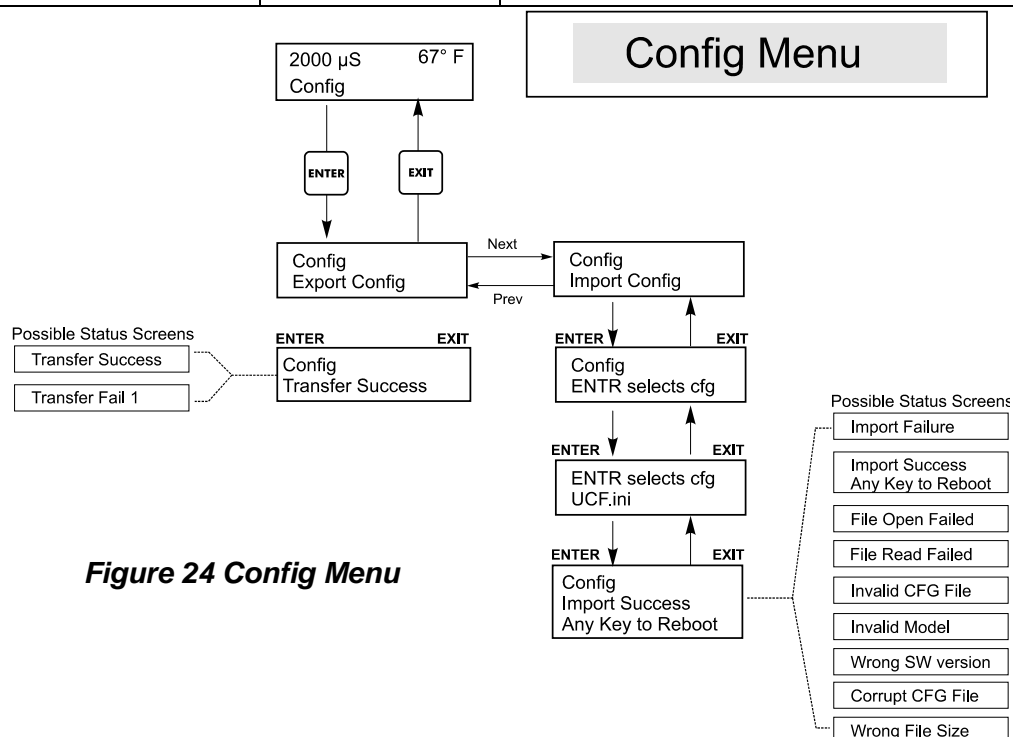


**Figure 23 Datalog Menu**

## 5.17 Config Menu

This menu allows you to export a file that contains all of the set points in the controller to a USB flash disk drive, and then later import the set points into another controller.

<b>Export Config</b>	Place a USB flash drive with at least 10 MB capacity into the USB port on the front panel of the controller. Press the Enter key to export the configuration file from the controller to the stick. The file name will be UCF.ini. If you are exporting files with different set points you may rename the file to something that describes it, as long as it has an ini extension.	
	The controller will display the progress of the file download process. If the file was successfully exported to the USB disk the controller will display Transfer Success, otherwise Transfer Fail 1.	
	<b>Transfer Success</b>	<b>Transfer Fail 1</b>
<b>Import Config</b>	Place a USB flash drive that contains only one configuration file stored on the root directory of the stick into the USB port on the front panel of the controller. Press the Enter key to import the configuration file from the stick to the controller. The file name must have an ini extension in its name.	
	The controller will display the progress of the file import process. If the file was successfully imported from the USB disk the controller will display one of the messages below:	
	<b>Import Failure</b>	Indicates that there were problems connecting to or accessing the USB stick.
	<b>Import Success: Any key to reboot</b>	The configuration file import succeeded and will be ready for use after reboot.
	<b>File Open Failed</b>	A config file could not be found on the USB stick or the USB stick file system could not be accessed.
	<b>File Read Failed</b>	The config file is too short (incomplete) or empty.
	<b>Invalid CFG File</b>	The imported file is not a valid config file.
	<b>Invalid Model</b>	The imported config file is not for this controller model.
	<b>Wrong SW Version</b>	The version of the imported config file is not compatible with this controller software version.
	<b>Corrupt CFG File</b>	The imported config file is corrupt. (The checksum failed.)
<b>Wrong file Size</b>	The size of the imported config file is wrong.	



**Figure 24 Config Menu**

## 5.18 Upgrade Menu

This menu is used to upgrade the software to a newer version. It is used to upgrade the software to a newer version. If a new version of the software is available, an upgrade file will be posted on our web site. Save this file to a USB flash disk drive. It needs to be the only executable (.exe file extension) file stored on the root directory of the stick. Press the Enter key to import the software upgrade file from the stick to the controller.

<b>Upgrade</b>	The controller will display the progress of the file import process. If the file was successfully imported from the USB disk the controller will display Transfer Success. The controller will automatically reboot and come up with the new software installed. If the software upgrade fails, you will see one of the following messages:	
	<b>UpgradFileInvald</b>	The file found on the USB stick is for the wrong product, or is corrupt. Try getting the correct upgrade file and make sure it's the only upgrade file on the stick.
	<b>No Upgrade File</b>	There is no upgrade file stored on the stick, or the file is named incorrectly.
	<b>CorrptUpgradFile</b>	Try getting a new copy of the file.
	<b>Flash Failure</b>	The flash memory on the processor board has a problem. Repair or replace the front panel assembly.

To check that it was successful, turn off power to the controller, then press the Enter key while turning power on. The controller will show the software version, which should match the name of the upgrade file that you used.

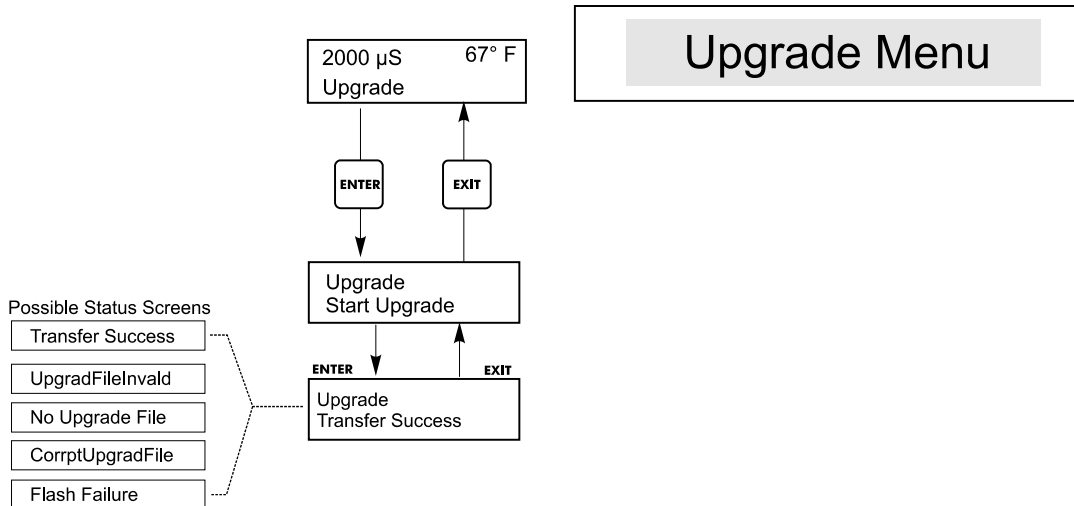


Figure 25 Upgrade Menu



## 6.0 MAINTENANCE

---

The WDT controller itself requires very little maintenance. Wipe with a damp cloth. Do not spray down the controller unless the enclosure door is closed and latched.

### 6.1 Electrode Cleaning

NOTE: The controller must be recalibrated after cleaning the electrode.  
Frequency

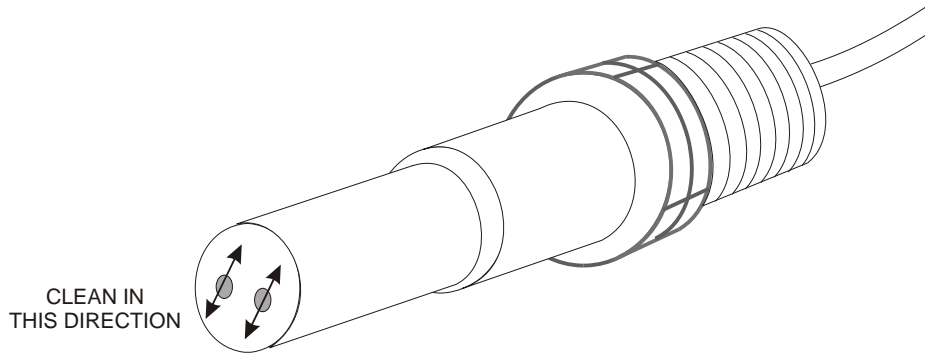
The electrode should be cleaned periodically. The frequency required will vary by installation. In a new installation, it is recommended that the electrode be cleaned after two weeks of service. To determine how often the electrode must be cleaned, follow the procedure below.

1. Read and record the conductivity.
2. Remove, clean and replace the conductivity electrode.
3. Read conductivity and compare with the reading in step 1 above.

If the variance in readings is greater than 5%, increase the frequency of electrode cleaning. If there is less than 5% change in the reading, the electrode was not dirty and can be cleaned less often.

#### *Cleaning Procedure*

The electrode can normally be cleaned using a cloth or paper towel and a mild detergent. If coated with scale, clean with a dilute (5%) solution of hydrochloric acid solution. Occasionally an electrode may become coated with various substances that require a more vigorous cleaning procedure. Usually the coating will be visible, but not always. To clean a coated electrode, use fine grit abrasive, such as emery paper. Lay the paper on a flat surface and move the electrode in a back and forth motion. The electrode should be cleaned parallel to the carbon electrodes, not perpendicular.



**Figure 26 Cleaning the Electrode**

## 6.2 Replacing the Fuses



CAUTION: Disconnect power to the controller before opening front panel!

Locate the fuses on the circuit board at the back of the controller enclosure. (See figure 3.) Gently remove the old fuse from its retaining clip and discard. Press the new fuse into the clip, secure the front panel of the controller and return power to the unit.

Warning: Use of non-approved fuses can affect product safety approvals. Specifications are shown below. To insure product safety certifications are maintained, it is recommended that a Walchem fuse be used.

F1 Fuse	Walchem P/N	F2 Fuse	Walchem P/N
5 x 20 mm, 1.0A, 250V	103163	5 x 20 mm, 6A, 250V	102834

## 7.0 TROUBLESHOOTING



CAUTION: Disconnect power to the controller before opening front panel!

Troubleshooting and repair of a malfunctioning controller should only be attempted by qualified personnel using caution to ensure safety and limit unnecessary further damage. Contact the factory.

### 7.1 Error Messages

#### **HIGH ALARM**

The summary screen will display an H at the right end of the bar graph if the conductivity rises above the high conductivity alarm set point. If your unit is wired for alarm output, the alarm relay will trip. The controller will continue to check the conductivity, and the bleed and/or feed outputs will be allowed to be activated.

Possible Cause	Corrective Action
Dirty electrode	Clean electrode (see Sect. 6.1)
Faulty solenoid valve	Repair or replace solenoid valve
Faulty electrode	Evaluate (see Sect. 7.3). Check Temp display.
Improper wiring of valve or controller	Correct wiring. See Section 3.4.
Conductivity rose over alarm limit while biocide lockout occurred.	Allow normal bleed to occur.
Clogged Y-strainer in bleed line	Clean Y-strainer.
Faulty bleed relay	Replace relay. (Consult factory.)

**LOW ALARM**

The summary screen will display an L at the left end of the bar graph and the alarm relay will trip. The controller will continue to check the conductivity and feed inhibitor as programmed.

Possible Cause	Corrective Action
Sensor disconnected	Reconnect. Check cable for continuity.
Sensor dry	Check tee for obstruction. Verify flow. Change location of electrode.
Pre-bleed set too low	Check pre-bleed setting compared to % low.
Solenoid valve stuck open	Repair or replace solenoid valve.(Consult your distributor)
Faulty electrode	Evaluate (see Section 7.3). Replace if necessary.
Improper wiring of electrode	Correct wiring. See Section 3.4.
Faulty bleed relay	Replace relay. (Consult factory.)

**NO FLOW**

This error message will stop all control. It indicates that the flow of sample past the electrodes and flow switch is less than « gallon per minute. This prevents controlling based upon a stagnant sample.

Possible Causes	Corrective Action
No flow	Check piping for closed valves, blockage, etc. Check recirculation pump.
Faulty flow switch/cable	Check with ohmmeter.
Faulty controller	Check by shorting flow switch input in controller.

**TEMP ERROR**

This error indicates that the temperature signal from the conductivity electrode is no longer valid. The controller will revert to manual temperature compensation.

Possible Cause	Correction Action
Green or white electrode wire disconnected.	Reconnect.
Faulty electrode.	Replace electrode.

**COND ERROR**

This error condition will stop conductivity control. It indicates that the conductivity signal from the electrode is no longer valid. This prevents controlling based upon a false conductivity reading.

Possible Cause	Corrective Action
Black or red electrode wire shorted	Disconnect short.
Faulty electrode	Replace electrode.
Faulty controller	Verify via failed self test.

**pH/ORP ERROR**

This error condition will stop pH/ORP control. It indicates that the pH/ORP input signal is out of the normal range and prevents controlling based upon a false pH/ORP reading. This usually indicates that the electrode has been disconnected or is faulty. It could appear under normal conditions if the pH is outside of the operating range of -2 to 16pH, or if the ORP is outside of the normal range of  $\pm 1450$  mV.

Possible Cause	Corrective Action
Controller is faulty; fails self test (see section 5.2)	Re-check pH self test with preamp disconnected. If it still fails, then send controller back for repair. If it passes, then preamp is faulty.
Preamplifier has no power to it.	If preamp is powered by the controller, check +5V, -5V terminals vs. COM terminal. Should read +5VDC $\pm 5\%$ and -5VDC $\pm 5\%$ . If battery powered preamp, replace battery.
Preamp is faulty.	Indicated if $\pm 5$ VDC power out of spec w/preamp attached, but in spec without preamp attached. Repair or replace preamp. Also indicated if power to preamp is OK but shorting the preamp input does not produce a stable signal within $\pm 5$ mV.
Electrode is faulty.	Replace electrode.

**BLEED TIMEOUT**

This error condition will stop conductivity control. It is caused by the bleed output being activated for longer than the programmed Bleed Time Limit.

Possible Cause	Corrective Action
Programmed value too low for normal conditions	Increase Bleed Time Limit.
Bleed flow rate too low	Check for clogged strainer. Check for insufficient pressure differential.
Bleed valve not opening	Check for faulty bleed valve. Check bleed valve wiring. Check controller relay.

**pH/ORP TIMEOUT**

This error condition will stop pH/ORP control. It is caused by the pH/ORP output being activated for longer than the programmed time limit.

Possible Cause	Corrective Action
Programmed value too low for normal conditions	Increase pH/ORP Time Limit.
Pumping problem	Check chemical supply. Check pump for prime. Check tubing for blockage or leaks. Verify pump is functional.
Controller problem	Check output wiring. Check controller relay

**FEED TIMEOUT**

This error condition will stop the feed pump for that particular feed cycle. If feed is initiated again, the feed pump will be allowed to activate. The error condition is caused by the feed output being activated for longer than the programmed time limit.

Possible Cause	Corrective Action
Programmed value too low for normal conditions	Increase Feed Time Limit (May also be called Max Time or Lockout)
Bleed took too long	See Bleed Timeout Troubleshooting. (Bleed & Feed or Feed as % of Bleed only)
Pumping problem	Check chemical supply. Check pump for prime. Check tubing for blockage or leaks
Controller problem	Check output wiring. Check controller relay.

**COND HIGH ALARM**

This error message indicates that the conductivity is above the programmed percentage above set point. The conductivity will continue to be monitored, and the bleed and feed outputs will be allowed to be activated.

Possible Cause	Corrective Action
Fouled conductivity electrode	See Conductivity Electrode Troubleshooting
Bleed flow rate too low	Check for clogged strainer. Check for insufficient pressure differential.
Bleed valve not opening	Check for faulty bleed valve. Check bleed valve wiring. Check controller relay.
Conductivity rose over alarm limit	Allow normal bleed to occur while biocide lockout occurred

**COND LOW ALARM**

This error message indicates that the conductivity is below the programmed percentage below set point. The conductivity will continue to be monitored, and the feed output will be allowed to be activated.

Possible Cause	Corrective Action
Fouled conductivity electrode	See Conductivity Electrode Troubleshooting
Electrode disconnected	Reconnect.
Electrode dry	See "No Flow "Troubleshooting section.
Bleed valve stuck open	Check for faulty bleed valve. Check bleed valve wiring. Check controller relay.
Biocide prebleed set too low	Change prebleed set point to be above low alarm if desired.

**pH HIGH ALARM**

This error message indicates that the pH is above the programmed pH High Alarm value. The pH will continue to be monitored, and the control output will be allowed to be activated. This troubleshooting assumes acid feed.

Possible Cause	Corrective Action
Pumping problem	Check chemical supply. Check pump for prime. Check tubing for blockage or leaks.

**ORP HIGH ALARM**

This error message indicates that the ORP is above the programmed ORP High Alarm mV value. The ORP will continue to be monitored, and the control output will be allowed to be activated. This troubleshooting assumes oxidizer feed.

Possible Cause	Corrective Action
Slow ORP electrode response	Clean and recalibrate ORP electrode. Replace ORP electrode
Oxidizer feed is too fast	Reduce flow rate of oxidizer feed pump or flow rate through brominator
Oxidizer feed pump is siphoning	Install, repair or replace anti-siphon valve. Relocate injection point where there is positive pressure
ORP control dead band too large	Reduce value of dead band
Brominator valve always open	Repair or replace control valve. Check wiring and relay

**pH LOW ALARM**

This error message indicates that the pH is below the programmed pH Low Alarm value. The pH will continue to be monitored, and the control output will be allowed to be activated. This troubleshooting assumes acid feed.

Possible Cause	Corrective Action
Slow pH electrode response	Clean and recalibrate pH electrode. Replace pH electrode.
Acid feed is too fast	Reduce flow rate of acid feed pump.
Acid feed pump is siphoning	Install, repair or replace anti-siphon valve. Relocate injection point to positive location pressure
pH control dead band too large	Reduce value of dead band.
Controller always powering pump	Check wiring and relay

**ORP LOW ALARM**

This error message indicates that the ORP is below the programmed ORP Low Alarm mV value. The ORP will continue to be monitored, and the control output will be allowed to be activated. This troubleshooting assumes oxidizer feed.

Possible Cause	Corrective Action
Pumping problem	Check chemical supply. Check pump for prime. Check tubing for blockage or leaks.
Brominator valve never opens.	Check wiring and relay. Repair or replace valve.

**TimeErr:SetTime!**

This error message is triggered by corruption of the clock chip. Biocide additions will be locked out until the clock time is reset.

Possible Cause	Corrective Action
Power spikes, high frequency noise	If this occurs frequently, install a power

## 7.2 Conductivity Readout Does Not Change

<b><i>If the readout is stuck at or near zero:</i></b>	
<b>Possible Causes</b>	<b>Corrective Action</b>
Dry electrode	Check for flow through system.
Electrode is disconnected	Check wiring to electrode. Go to self-test menu as described in section 5.2. If readout changes to 900-1100, the problem is with electrode or connections. See section 7.3 If still at zero, problem is with controller. Consult the factory.
<b><i>If the readout is stuck at another number:</i></b>	
<b>Possible Causes</b>	<b>Corrective Action</b>
Dirty or faulty electrode	Evaluate electrode (section 7.3).
Stagnant sample	Check system for proper flow.

## 7.3 Procedure for Evaluation of Conductivity Electrode

Can be used for troubleshooting low conductivity, high conductivity, conductivity stuck at 0, cal failure, and/or conductivity stuck at a number other than 0.

Try cleaning the electrode first (refer to Sect. 6.1).

To find out if the electrode or the controller is faulty, step through the Self-Test menu, as described in section 5.2. The display should read  $1000 \mu\text{S} \pm 100 \mu\text{S}/\text{cm}$ . This indicates that the controller is OK and the problem is in the electrode or its connections. If it does not read  $1000 \pm 100 \mu\text{S}/\text{cm}$ , return the control module for repair.

To check the electrode, check the electrode connections to the terminal strip (refer to Figure 3). Make sure that the correct colors go to the correct terminals, and that the connections are tight. Restore power and see if the conductivity is back to normal. If not, replace the electrode.

## 7.4 Procedure for evaluation of the pH/ORP electrode

The least common cause of a calibration failure is a control module problem. To eliminate this possibility, perform a self test of the controller. If this says "PASS," you'll need to troubleshoot the electrode, preamplifier and cabling. If it says "FAIL," then the controller need to be returned for repair.

The most common cause of a calibration failure is an electrode problem. First try cleaning the electrode, then retry the calibration. If this fails again, replace the electrode and retry the calibration.

The next most common problem is wet or poor connections. Check the connection of the electrode to the cable for moisture. Check the connections between the cable and the terminal strip. Make sure that they are tight, that the terminal is not clamped to the plastic jacket, and that the wires are routed to the correct terminal. If there is a junction box installed between the electrode and the controller, check the wiring there as well.

You should be able to measure the  $+5\text{VDC} \pm 5\%$  and  $-5\text{VDC} \pm 5\%$  vs IN- at the terminal strip. If not, the controller is faulty. You should be able to measure the IN+ vs IN- (DC scale) and get the appropriate values for the buffer solutions used. If not, the preamplifier or its wiring is faulty.

The last possibility is to try replacing the preamplifier.

## 7.5 Procedure for checking relay outputs

If any prewired output is not activating the device (pump, valve, etc.) attached to it:

If the relay is internally powered, verify that the F2 fuse is OK by measuring the AC voltage between Neutral and both ends of the fuse.

Verify that the pump or valve is not faulty by plugging it directly into a wall socket.

In some controllers, certain relays are NOT internally powered. Check the instruction manual to determine if the relay is a dry contact type. If so, make sure that external power (VAC) has been connected to the relay. In most cases, this will be a jumper wire from the large screw labeled "HOT" to one of the relay terminals.

Manually activate the relay using the hand-off-auto menu. Verify that the LED on the front panel lights up. If the device turns on, there must be a problem with the set points if the device doesn't turn on when it should.

With power removed, check the wiring of the pigtail to the terminal strips. Make sure that they are not loose, that they are not connected by the wire's jacket, and that they are connected to the correct terminal. Also check the removable terminal block where the black (hot) wires attach (TB2) to see if it has pulled loose. Restore power and manually activate the relay.

With power removed, remove the terminal block that has the black (hot) wires from all of the pigtails (TB2). This simply pulls up off some metal pins. Check these pins for corrosion. If they seem coated with anything, scrape off the coating by replacing and removing the terminal block several times. Restore power and manually activate the relay.

With power removed, remove the TB2 terminal block again and attach one lead of a multimeter to the pin that lines up with the wire for the relay in question, and the other lead on the other side of the relay (this will be an adjacent pin for a dry contact relay, or neutral at TB3 for a powered relay). For a dry contact relay, set the meter to read resistance. Restore power and verify that the meter reads infinite ohms with the relay off (open) and very low ohms with the relay on (closed). If it always reads infinite ohms, the power supply board is faulty. For a powered relay, set the meter to read AC voltage. Restore power and verify that the meter reads <5 VAC with the relay off (open) and line voltage with the relay on (closed). If it always reads <5 VAC, the power supply board is faulty.

## **8.0 SERVICE POLICY**

---

The WDT410 series Cooling Tower Controller has a 2-year warranty on electronic components and a 1-year warranty on mechanical parts (keypad, terminal strip and relays).

We stock circuit boards for immediate exchange after we have isolated the cause of the problem.

Factory authorized repairs that are received by next-day-air will be returned within 24 hours. Normal priority for returns is two weeks.

Out of warranty repairs or circuit board exchanges are done on a flat fee basis after the warranty is expired.



# Model Code

WDT410

-

Voltage

Output

Sensor

U (USB)

## VOLTAGE

- 1 = 120 VAC, prewired
- 5 = 100-240 VAC, conduit

## OUTPUT

- N = No data output
- 4 = Single 4-20 mA output
- 2 = Dual 4-20 mA output (WDT)

## SENSOR

- N = No electrode

## WDT410

- 1 = SS + pH electrodes & tees, (inline or submersion), 20ft. (6.1m) cable
- 2 = SS + ORP electrodes & tees (inline or submersion), 20 ft. (6.1m) cable
- 3 = SS + pH electrodes & flow switch manifold on PP panel, 5ft. (1.5m) cable
- 4 = SS + ORP electrodes & flow switch manifold on PP panel, 5ft. (1.5m) cable
- 6 = Graphite + pH electrodes & tees (inline or submersion), 20ft. (6.1m) cable
- 7= Graphite + ORP electrodes, & tees (inline or submersion), 20ft. (6.1m) cable
- 7R= Graphite + ORP rod style electrode & tees, ft. (inline or submersion), 20ft. (6.1m) cable
- 8 = Graphite + pH electrodes & flow switch manifold on PP panel, 5ft. (1.5m) cable
- 9 = Graphite electrode, ORP electrode & flow switch manifold on PP panel, 5ft. (1.5m) cable
- 9R= Graphite + ORP rod style electrode & flow switch manifold on PP panel, 5ft. (1.5m) cable
- A = High pressure electrodes (Cond + pH) & flow switch manifold on PP panel, 5ft. (1.5m) cable
- B = High pressure electrodes (Cond + ORP) & flow switch manifold on PP panel, 5ft. (1.5m) cable

## USB FEATURES

- U = Integrated datalogging, event/reset logging, and configuration file import/export

**FIVE BOYNTON ROAD**  
**TEL: 508-429-1110**

**HOPPING BROOK PARK**  
**FAX: 508-429-7433**

**HOLLISTON, MA 01746 USA**  
**Web: [www.walchem.com](http://www.walchem.com)**